

Best Practice Guide Air Sealing and Insulation Retrofits

For Single Family Homes

2018 Second Edition



BC HOUSING

RESEARCH CENTRE

Acknowledgements



BC Housing gratefully acknowledges the invaluable support and funding contributions of the BC Ministry of Energy and Mines, FortisBC and BC Hydro in the production of this guide. This guide was prepared by RDH Building Science Inc. with assistance from Innes Hood Consulting, Ken Farrish Marketing, and Constructive Home Solutions. Additional acknowledgement is extended to Quality Program Services for providing technical consultation and weatherization sites for documentation. In addition, gratitude is extended to the participants of the BC Hydro and Fortis BC Home Renovation Rebate program, which informed the additional content of this second edition publication.

Disclaimer

This publication is provided for general information only. The greatest care has been taken to confirm the accuracy of the content. However, the authors, funders, publisher, members of the project steering committee and other contributors assume no liability for any damage, injury, loss or expense that may be incurred or suffered as a result of the use of this publication, including products, building techniques or practices. The views expressed do not necessarily represent those of any individual contributor, BC Housing, FortisBC, or BC Hydro.

Building science, products and construction practices change and improve over time and it is advisable to regularly consult up-to-date technical publications on building enclosure science, products and practices rather than relying solely on this publication. It is also advisable to seek specific information on the use of products, the requirements of good design and construction practices, and the requirements of the applicable building codes before undertaking a construction project. Refer to the manufacturer's instructions for construction products, and also speak with and retain consultants with appropriate engineering or architectural qualifications, and appropriate municipal and other authorities, regarding issues of design and construction practices. Most provisions of the building codes (British Columbia Building Code and the Vancouver Building Bylaw) have not been specifically referenced. Always review and comply with the specific requirements of the applicable building codes and bylaws for each construction project. Nothing in this publication is an endorsement of any particular product or proprietary building system.

Preface

About this Guide

Best Practices for Air Sealing and Insulation Retrofits for Single Family Homes is published by BC Housing. This guide consolidates best practices for air sealing and insulation retrofits (i.e. building enclosure weatherization) for British Columbia homes. It does not cover mechanical systems, appliances, or lighting.

The guide is intended to be a reference tool for construction industry professionals and can help contractors learn how to perform weatherization work. It is similar to other contractor-focused weatherization program training guides, but with specific regard to British Columbia's unique climate, construction practices, and building code requirements.

The information may also interest homeowners performing home retrofits without a contractor, though is not written for the do-it-yourself audience. Guides such as *Keeping the Heat In*, published by Natural Resources Canada, or *Insulate and Weatherize—Build Like a Pro Series*, from the Taunton Press (see [Additional Resources](#) on page 84), are examples of publications that are more appropriate for homeowners planning to undertake the work themselves. Homeowner tips are provided in this guide to assist with operation and maintenance.

Background

Air sealing and insulation retrofits of homes are reliable methods to reduce energy consumption, improve durability, reduce utility bills for the home owner, and reduce the gas and electric load.

Building enclosure weatherization retrofits primarily consist of air sealing and adding or upgrading insulation in the building enclosure, either as a stand-alone activity, or during other planned renovation and repair activities.

Simple weatherization work can be performed by homeowners or occupants, while more advanced activities and extensive repairs or renovations typically involve a contractor. There are many health and safety issues to consider when working in existing homes and handling different building materials (see [Health and Safety Considerations](#) on page 6).

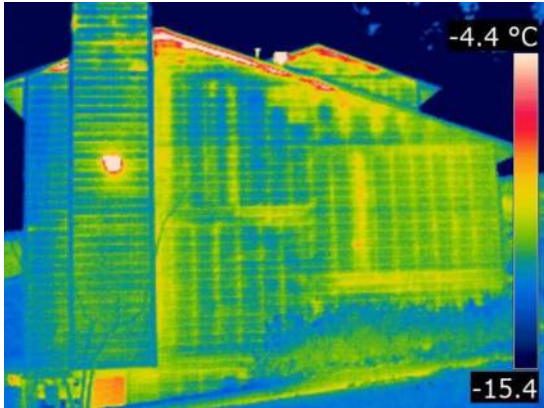

Infrared images can identify insulation discontinuities and air leakage locations, which can assist contractors with weatherization retrofits.



Insulation retrofit of an attic using blown-in cellulose added after air sealing and insulating with polyurethane foam.



Air sealing of an electrical penetration and unsealed top-plate connection in an attic.

Scope

The guidance in this publication applies to wood-frame residential detached, semi-detached (e.g. duplex to quadplex) and row house/townhomes in British Columbia. Non wood-frame homes, mobile homes, and multi-storey multi-unit residential buildings are beyond the scope of this guide.

Specifically, the guide provides procedures for common air sealing and insulation installation for attics and roofs, above-grade walls, basements, crawlspaces, floors, and the interfaces within and between these assemblies.

This guide also includes some guidance on the weatherization or replacement of windows or doors. Further guidance on this work is covered in the *Best Practices for Window and Door Replacement in Wood-Frame Buildings*, published by BC Housing. Additionally, this guide does not cover measures that relate directly to heating, cooling, and ventilation systems. Guidance on some aspects of this work is contained in the *High-Efficiency Furnace Installation Guide for Existing Houses*, published by Fortis BC (see [Additional Resources](#) on page 84).

It is important to note that each home and weatherization project presents unique conditions. This guide provides recommended best practice techniques, but it is likely that these methods will need to be adapted to accommodate the variations in each project.

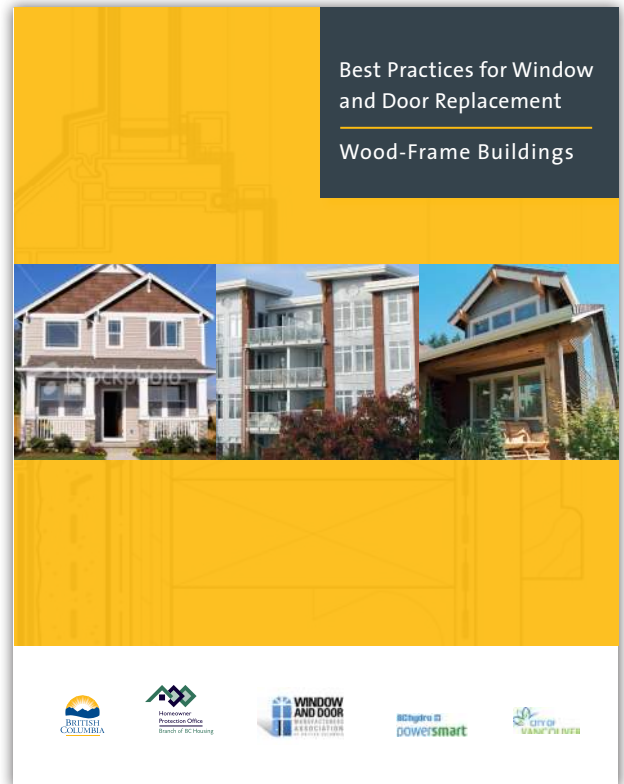

Table of Contents

Section 1 | Project Considerations

House as a System: Effects of Air Sealing and Insulation Retrofits	2
Air Sealing and Insulating Retrofit Considerations for British Columbia	5
Health and Safety Considerations	6

Section 2 | Retrofit Project Evaluation

Initial Assessments	10
Energy Performance Assessment	11
Evaluating Air Sealing Needs	12
Determining Assembly & Component Upgrades	14

Section 3 | Air Sealing and Insulation Retrofit Procedures

Retrofit Procedures	16
List of Procedures	17
Accessible Attic Ceiling Spaces	18
Inaccessible Attics and Vaulted/Flat Ceilings	49
Above-Grade Walls	53
Exposed Floors	65
Below-Grade Walls	69
Crawlspaces	75
Windows and Doors	81

Section 4 | Further Information

Additional Resources	85
References	87

Section 5 | Appendices

Contractor Checklist: Home Air Sealing Insulation Procedures	88
Contractor Checklist: Health and Safety	89
Glossary of Terms and Materials	90

House as a System: Effects of Air Sealing and Insulation Retrofits

A house is made up of numerous parts, including the building enclosure, the structure, interior finishes, mechanical equipment, and electrical and lighting, which all interact with each other to form a system. The performance of one part of a house depends on its relationship with other parts of the house.

The Building Enclosure

The building enclosure, also called the envelope, is itself a system of materials, components, and assemblies that physically separate the exterior and interior environments. It comprises various elements including roofs, above-grade walls, windows, doors, skylights, below-grade walls, and floors. These assemblies in combination must control movement of water, air, heat, water vapour, fire, smoke, and sound.

To perform these functions, building assemblies typically use a series of layers, each intended to serve one or more functions within the building enclosure. In walls, for example, depending on the age of the building, the cladding is installed as the water-shedding surface and a water-resistive barrier installed inboard of the cladding as a secondary barrier to prevent water ingress. A vapour retarder is installed to control diffusion of water vapour through the wall assembly. Insulation is installed to control the flow of heat through the enclosure, and an air barrier is installed to control bulk air movement through the assembly. It is the insulation and air barrier that are intended to provide the most direct control of energy flow through the building enclosure.

The Air Barrier resists airflow between the interior and exterior spaces. Heat loss occurs through the enclosure due to airflow, where interior conditioned air escapes or exterior air infiltrates. Both airflow mechanisms can account for a significant portion of the energy use in a home. Air leakage can also cause durability issues due to the introduction of moisture into the assembly.

Insulation in the building enclosure resists heat flow using materials with low conductivity (i.e. high thermal resistance). The measure of the resistance to heat flow is expressed in the metric units of RSI ($m^2 \cdot K/W$) and the imperial measurement of R-value ($ft^2 \cdot ^\circ F \cdot hr/Btu$). The more insulation in the assembly, the higher the assembly R-value and the greater its resistance to heat flow.



All the parts of the house including its contents and occupants interact together to form an integrated system. This is imperative to understand when performing air sealing and insulation work. This guide covers air sealing and insulation weatherization work for all parts of the house from the basement to the attic.

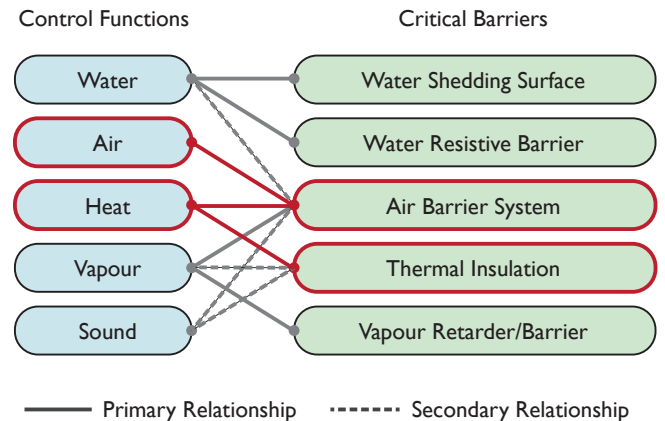

The various elements of the building enclosure serve as critical barriers, functioning to control the elements and separate the interior from the exterior environment.

The Mechanical System

A home's heating, cooling, and ventilation systems are particularly important in the context of energy efficiency. For example, the heating and cooling systems will not run at optimal performance or efficiency if the house's building enclosure allows a lot of air leakage or is poorly insulated. One of the main goals of the air sealing and insulation work should be to reduce energy loss through the enclosure and thus reduce space heating (and cooling) costs. In addition, the interior air quality may be poor if the ventilation air is not well controlled through mechanical means, where air is brought in through filters to remove contaminants in the air, but instead enters through openings in the building enclosure.

However, weatherization of older homes with significant air leakage can also create new problems. For example, if a house is made significantly more airtight, it could cause naturally-aspirated combustion equipment — including furnaces, fireplaces and hot-water heaters — to backdraft and spill carbon monoxide and other dangerous combustion gases into the home if the space becomes negatively pressurized. Sources of negative pressure include exhaust fans for kitchen range hoods, clothes dryers, bathroom fans, and chimneys. If extensive weatherization is planned, air sealing work should account for the combustion and ventilation mechanical equipment by including passive air inlets or installing new mechanical equipment with dedicated combustion air intakes.

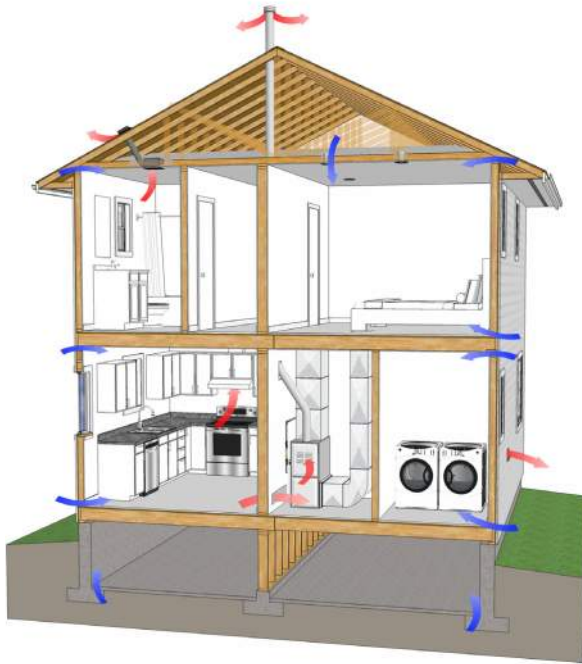

Mechanical equipment within a house may rely on natural air infiltration due to air leakage as the combustion air for combustion appliances.

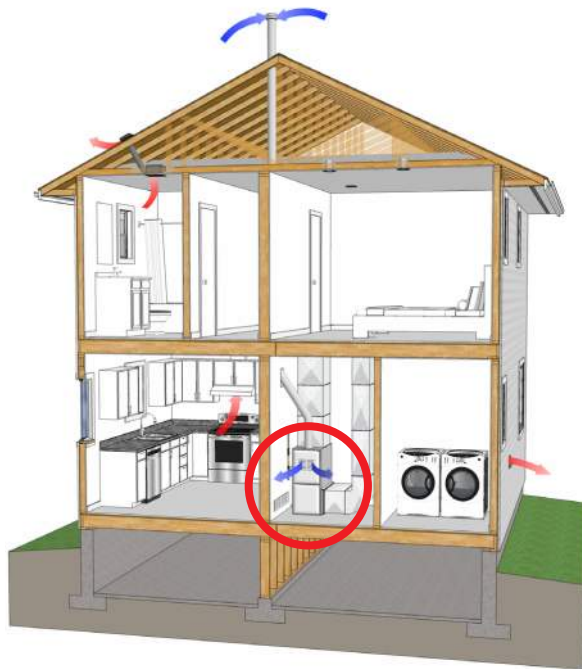

Dramatically improving the building enclosure airtightness may pose a risk of mechanical malfunction and backdrafting if no other combustion air supply inlet is provided.

Durability

The weatherization work should aim to increase the thermal resistance of the building enclosure and improve its airtightness, without compromising the durability of the assemblies. The following durability concerns exist:

- Air flowing through the assembly from the interior to the exterior may carry interior moisture vapour into contact with colder surfaces closer to the outside of the assembly, leading to condensation and potential mould growth and deterioration within the assembly. If insulation is added to an assembly without adequate air barrier improvements, the interior surfaces can become colder and be more prone to condensation.
- Vapour diffusion from interior to exterior may also contribute to the moisture transfer through and into an assembly, and must also be accounted for in weatherization work. An effective vapour barrier should be in place at the interior (warm) side of all assemblies. However, certain assemblies, especially those with minimal existing insulation, may rely on some level of drying of moisture that may enter the assembly. Also, the addition of new exterior insulation may inhibit outward drying capability of the assembly. In general, an assembly that uses a vapour barrier at the interior and vapour-open materials for the rest of the assembly is the safest approach.
- Where weatherization work requires removal of existing layers like cladding or roofing, care must be taken to replace materials and components so that the exterior moisture protection is not compromised. Most often, where cladding must be removed to access the wall assembly in order to add insulation or improve airtightness, a new water-resistive barrier and new cladding should be installed using modern water deflection and moisture management design and installation principles. An air sealing and insulation retrofit that includes new exterior components can be an effective way to improve the durability of the assembly, and is a recommended approach.
- Some insulation and sealant materials contain volatile organic compounds (VOCs) and other harmful chemicals and must be used carefully and properly ventilated until cured.
- Care must be taken when selecting building materials as some materials are incompatible with each other and with existing building components such as electrical wiring and plastics.

Trained weatherization professionals who conduct home energy evaluations (for example Energy Advisors with the NRCan EnerGuide rating system) and contractors who perform air sealing and insulation work should ensure they understand the interactions of airtightness, insulation, and mechanical and ventilation equipment, as well as the durability considerations, and should be aware of possible remedial measures.

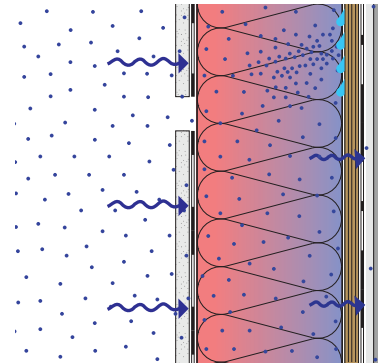

Potential condensation caused by air leakage through the enclosure assembly presents a risk to the assembly's durability.

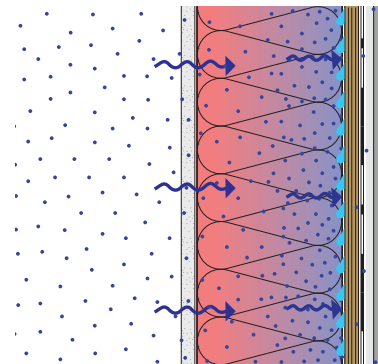

Potential condensation caused by vapour diffusion could be exacerbated by increased interior insulation, creating colder surface temperatures at the exterior enclosure elements.

Air Sealing and Insulating Retrofit Considerations for British Columbia



8	> 7,000 HDD
7B	6,000 to 6,999 HDD
7A	5,000 to 5,999 HDD
6	4,000 to 4,999 HDD
5	3,000 to 3,999 HDD
4	< 3,000 HDD

Heating Degree Day (HDD) map of BC showing approximate Climate Zones 4 through 8 as defined in the National Energy Code for Buildings and the BC Building Code (BCBC). Note that actual HDD values are found in the BC Building Code and are available online for many municipalities.

More than one million detached and low-rise wood-frame homes have been constructed in B.C. in the past century. Over the past decades, insulation levels and building enclosure airtightness have evolved. Older homes tend to be poorly insulated and have more air leakage compared with new homes. In general, older homes will benefit more from insulation upgrades, as insulation levels before the 1980s were relatively low, in particular in basements and crawlspaces. Attic insulation levels in houses constructed before the 1990s are also typically low. Even newer homes constructed in the past two decades will benefit from air sealing work, as this is often overlooked during construction. Air sealing efforts are unlikely to provide a significant benefit for new homes that were constructed with a focus on airtightness.

The optimal amount of insulation for a wall, floor, or roof depends on where the home is located within B.C. Houses in the colder regions need to have more insulation and be more airtight in order to be comfortable in the wintertime and use as little space-heating energy as possible.

The following airtightness targets and insulation levels (nominal R-value) are recommended for homes in B.C., based on best practices and insulation retrofit potential. Note that these are not code-required values; insulation requirements (effective R-value) of the 2012 BC Building Code can be found in the BC Housing published *Illustrated Guide - Energy Efficiency Requirements for Houses in British Columbia* (see [Additional Resources](#) on page 84), which should also be consulted for guidance regarding required and optimal insulation levels. Upgrading a house to the current code minimum can be costly. Some levels of insulation or air sealing may not provide significant utility bill savings, depending on the home, but could improve thermal comfort.

Recommended Airtightness Targets and Insulation Levels for Homes in BC

Wood-frame Building Enclosure Assembly	Zones 4 & 5 ≤3999 HDD	Zone 6 4000-4999 HDD	Zone 7A 5000-5999 HDD	Zone 7B & 8 ≥6000 HDD
Attic Spaces	R-40	R-50	R-60	R-60
Cathedral or Flat Roofs	R-30	R-30	R-35	R-40
Above-grade Walls	R-20	R-25	R-25	R-30
Below-grade Walls	R-20	R-20	R25	R-25
Suspended Floors	R-25	R-30	R-40	R-50
Slab-on-grade Floors	R-10	R-15	R-20	R-25
Airtightness (ACH50)	<5 ACH	<4 ACH	<3 ACH	<2 ACH

Health and Safety Considerations

With proper precautions and training, air sealing and insulation weatherization work on homes should pose little to no threat to the health and safety of the contractor or the occupants of the home. However, improperly used building materials and tools can be dangerous to users or occupants, or can damage the building, so it is important that contractors read and follow all manufacturers' recommended safety and installation procedures. Wherever possible, less harmful and lower VOC air sealing and insulation materials should be used, particularly if materials will be exposed to interior living space.

The following pages summarize some of the key points to consider, with references provided for further information on occupational health and safety procedures. A health and safety checklist for contractors, provided in the appendices, covers some of the major considerations. However, the health and safety information in this guide is neither comprehensive nor complete, and those performing weatherization work should always be appropriately trained and aware of the safety risks associated with the work.

Occupant Safety

Proper health and safety precautions should be used during retrofit work to protect the occupants from harm. Non-climbable guards should be installed to block off access to areas of potential danger, such as openings in floors or areas with risk of falling objects. Areas of work which may contaminate indoor space with potentially harmful dust or debris should be sealed off. Consider the effect of using or storing chemicals inside the home, and inform the occupants of any compromises to the air quality at any time. Equipment, tools and material should be safely used and stored, and out of reach of children. Be mindful not to block the occupants from exiting the building in case of an emergency.

Fall Safety in Attics

Working in attics can be difficult and dangerous as tripping hazards such as wires and exposed nails may be hidden by insulation or hard to detect due to poor lighting. The ceiling finish has no structural capacity to support a falling worker. To reduce the risk of injury, the attic conditions should be assessed and appropriate fall protection systems should be implemented. Use adequate lighting devices such as area flood lights or headlamps.

Ladder Safety

During air sealing and retrofit work ladders may be used to access attics, crawlspaces, ceilings, roofs and exterior walls. Choosing, inspecting, setting up, and working safely from ladders is essential as they are a frequent source of injuries in the work space. Ladders should be chosen by type of work and access requirements, and should always bear on stable ground in low hazard areas. Workers should always face the ladder and maintain three points of contact with the ladder while ascending and descending. Further information on safe work practices for ladders can be found at www.worksafebc.com.

Confined Spaces

A confined space is an area which is enclosed or partially enclosed, is not intended for continuous human occupancy, has restricted means of entry, and is large enough and configured so that a worker could enter to perform assigned work. Crawlspaces are considered to be confined spaces, as they are often poorly ventilated and may contain radon gas and VOCs from oil leaks, gas leaks or contaminated soil. Attics are not necessarily considered confined spaces, but share many similarities, as they are difficult to rescue out of and can contain animal waste and dust which could be toxic or contain viruses. Appropriate respirator protection should be worn when first examining the area of work in crawlspaces and attics. Further information is provided by Work Safe BC and available at www.worksafebc.com.

Ventilation while Performing Work

Many sealants, adhesives, and spray polyurethane foams release VOCs and other potentially harmful chemicals when curing. The product manufacturers' installation and safety procedures should be followed when performing work, and ventilation should be provided as required: opening windows, using temporary ventilation fans or using full respiratory equipment, depending on the nature of the work being performed. In some cases, for example when using large quantities of spray polyurethane foam in attics, roofs, or walls, contractors need full respiratory equipment while in the work area and occupants may need to leave the house for up to 24 hours after spraying, where all windows are kept open for a full-house flush. Note that there is an increasing number of available products that release little or no VOCs.

Lead Paint

Lead can be found in many paints and coatings used in buildings until the 1980s. Lead-containing paints and coatings do not present a hazard if they are left intact. However, if weatherization work damages or removes materials containing lead, appropriate safety measures must be followed. Further information can be found in *Lead-Containing Paints and Coatings*, published by WorkSafeBC and available at www.worksafebc.com.

Asbestos-containing Products and Vermiculite Insulation

In many older homes, particularly those built before the 1990s, asbestos fibres may be found in building products such as vermiculite insulation, asbestos cement board siding, asbestos pipe insulation, drywall joint compound, stucco, and some older window putties. Even newer homes may contain asbestos in some components. Undisturbed materials within walls or attic spaces pose little risk to occupant health. However, if exposed or disturbed as part of a weatherization program these materials can cause health risks to both the contractor and occupants. At minimum, contractors and homeowners should consult the following publications prior to undertaking weatherization work: *It's Your Health—Vermiculite Insulation Containing Amphibole Asbestos*, published by Health Canada; *Asbestos Hazards When Renovating Older Homes* and *Safe Work Practices for Handling Asbestos*, both published by WorkSafeBC and available at www.worksafebc.com.

Electrical Wiring

Care must be taken when working around electrical wiring so as not to receive a shock, damage the wiring, or cause a fire. Air sealing materials such as spray foam should never be applied within electrical boxes or come into contact with bare wires. Use of these materials around electrical connections requires special attention. Always follow the product manufacturers' instructions and warnings, and hire an electrician if any electrical work is needed.

Radiant ceiling heating panels installed prior to 1995 are advised to be disconnected as per BC Safety Authority's 1993 and 1994 disconnect orders as they are deemed unsafe. Some B.C. homes may still have active knob-and-tube wiring. The house must be rewired and the knob-and-tube wiring decommissioned prior to the attic being air sealed and insulated. If in doubt, hire an electrician to review the wiring and perform any necessary work.

Rodents and Insects

Crawlspaces and attics can contain potentially dangerous animals and insects. Animals like rats, bats and even raccoons can be found in these spaces. They can become aggressive and cause serious injury or disease. Venomous insects may also be present and can potentially cause injury, though they are less common. The attic and crawlspace should be entered carefully at first, and adequate lighting should always be used in these spaces. If rodents or an insect infestation is discovered in the home, a professional pest control company should be used for removal. If bitten or harmed by a wild animal, seek medical attention immediately.



Vermiculite attic insulation potentially containing asbestos fibres.



Knob-and-tube wiring.

Radon Gas

Radon is a colourless, odourless and tasteless radioactive gas that is produced by the breakdown of uranium in soil and rock. Radon is present in outdoor air at low concentrations and is harmless. However, in an enclosed house, radon can build up and create a long-term health risk to occupants. The concentration of radon within a home depends on the radon concentration in the soil below the house, the pressurization of the home (i.e. depressurization pulls radon in through foundation cracks), and the house ventilation rate. Air sealing and insulation weatherization work in a basement or crawlspace (e.g. sealing foundation cracks and gaps) can help reduce radon concentration, though at the same time, air sealing work can lead to a more airtight home that is then prone to more depressurization and poor ventilation (unless addressed).

Radon is more of a concern for homes east of the Coast Mountains in the interior of B.C., than it is for homes in coastal B.C. When performing weatherization work in homes within potentially affected areas, basement and crawlspace sealing is recommended before attic or above-grade work. Where radon is a concern, testing should be performed and is relatively inexpensive. Further information can be found on the HealthLinkBC website www.healthlinkbc.ca.

Mould, Fungal Growth, and Moisture Damage

Fungal contamination and mould can occur in homes and concealed building enclosure assemblies if the materials are exposed to elevated relative humidity levels (typically above 80% RH for extended periods) and/or condensation. Organic materials, such as paper-faced drywall and wood, are susceptible to fungal growth in the home. Fungal growth is also common in bathrooms, but easily removed by regular household cleaning. Fungal growth on window frames may occur if there is excessive condensation due to high indoor relative humidity levels. Fungal growth is also commonly found in crawlspaces, attics, and other damp spaces as a result of elevated relative humidity levels, condensation, rainwater, and plumbing and appliance leaks.

Depending on the severity and duration of the wetting, fungal growth can lead to decay and deterioration of wood components. Moisture-damaged wood is somewhat common in many B.C. homes and is often discovered during weatherization work.

If significant fungal contamination or mould is present or suspected in the home, it must be removed and cleaned and the contributing source addressed prior to any air sealing and insulation weatherization work. To control and reduce the potential for mould growth, indoor moisture sources and indoor humidity must be controlled. This can be achieved by the combination of a proper ventilation system with good distribution in the home, and source moisture control. Additional information can be found in *Keeping the Heat In*, published by Natural Resources Canada (see [Additional Resources](#) on page 84). A good reference on wood durability, including procedures for the remediation of moisture-damaged wood buildings, can be found at the Binational Softwood Lumber Council website www.softwoodlumber.org.

Where mould growth is severe or moisture damage is extensive, a professional specializing in mould clean-up and structural repair should be retained. The document *Guidelines on Assessment and Remediation of Fungi in Indoor Environments*, published by the New York City Department of Health and Mental Hygiene, is a good reference for remediation procedures. When cleaning up mould-contaminated building materials, WorkSafeBC occupational health and safety regulations should be followed (Guidelines Part 4 - Indoor Air Quality).

Structural Elements and Connections

Structural elements of the home should not be compromised during weatherization work even if it is necessary to cut, drill, or relocate wood structural elements during renovation work. Contractors should avoid cutting wood elements such as studs, trusses, joists and beams when air sealing or insulating, unless a structural engineer has been retained to review the modifications and suggest remedial or reinforcing techniques.

Ventilation of the Home

Air sealing work seals openings in the building enclosure that may have previously been relied on for natural or passive ventilation in the home. Inadequate ventilation can lead to indoor air quality concerns and moisture problems, and therefore a properly functioning and sized mechanical ventilation system is necessary. Further information can be found in numerous resources on ventilation system design including Chapter 18 of the new *Canadian Home Builders' Association Builders' Manual*, and TECA's *Quality First Ventilation Guidelines* (see [Additional Resources](#) on page 84).

Materials Containing Solvents and VOCs

Sealants, adhesives, and other products used for air sealing and insulation weatherization work may contain flammable solvents and VOCs that can affect contractor or occupant health and safety. Low-VOC options for many adhesives, paints and sealants are available and should be used when possible for indoor work, though the use of higher VOC products may be required for some applications. Additional health and safety information can be found by reviewing the product literature and manufacturers' material safety data sheets.

Spray Foam Insulation

Spray polyurethane foam (SPF) is a commonly used air sealing and insulation material for weatherization work and this guide suggests its use in various applications. Exposure to isocyanates and other chemicals in the spray foam during the curing period or for some time after installation may cause health effects in some people. Care must be taken to control exposure of contractors and the occupants, including possibly vacating the home while spray foam is being applied and for up to 24 hours for large applications. In addition, some spray foam types (closed cell, medium density products) can only be applied in lifts of up to 2" at a time, should not be used to fill closed cavities, and require a cooling-off period between lifts for thicker applications.

Spray foam should always be installed by a trained contractor. This guide does not provide information or instruction on SPF installation and safety procedures. Refer to spray foam manufacturers for health and safety information. The US EPA has a website on the use of SPF in the home (www.epa.gov).

Gas Safety

Air sealing and insulation weatherization work typically does not require the movement or relocation of gas lines or equipment. However, if a smell of gas is detected or gas equipment work is required, proper procedures must be followed by a trained contractor. For example, modifications may be required after a failed combustion safety test on a weatherization project. B.C.-specific information can be found at the BC Safety Authority (www.safetyauthority.ca) as guidance is not provided here.

Combustion Safety

Air sealing and insulation weatherization work can affect the combustion safety of a home. Appliances with natural draft chimneys, such as gas or wood-burning fireplaces, or gas and oil-burning appliances like boilers, furnaces, or water heaters, may rely on natural air leakage through the enclosure to provide the makeup air for combustion. Some homes may have dedicated combustion air vents (that must not be sealed during weatherization work). If extensive air sealing and weatherization work is performed on a home with a natural draft chimney, this makeup air may be reduced to a point where the equipment or fireplace may backdraft and spill combustion gases into the home. When weatherization work is undertaken, a direct supply of makeup air for these systems may be required. It can be more difficult to provide make-up air in homes with unvented fuel heaters or gas fireplaces, so these may need to be removed prior to weatherization work.

Note

Weatherization work in homes with gas, oil, or wood-burning equipment requires special consideration and combustion safety testing. Guidance for addressing combustion safety, testing, and remedial measures are beyond the scope of this guide. Several references are provided in Section 5 at the end of this guide. Contractors performing weatherization work should be knowledgeable on these issues prior to performing any work.

Other Considerations

Weatherization work can sometimes uncover other issues in a house. For example, exhaust fans may be directly vented into the attic instead of outdoors, or the basement may be found to be leaking. In these cases, any problems must be addressed before or as part of the weatherization work.

Initial Assessments

Before starting any retrofit project, it is important to assess all potential environmental hazards related to the project. Consult the BC Housing's *Managing Environmental Risks During a Renovation Project Builder Insight Bulletin* for guidance with this aspect of the retrofit project.

While almost every part of an old building can be better insulated and made more airtight, it is important to know which energy efficiency measures could have the largest effect on the performance of the home. The first concept to understand is the role that stack effect plays in the air movement of the house. At the bottom of the house, cold air is drawn in as shown in the adjacent schematic, and at the top, warm air is pushed out into the attic. As a result, air sealing and insulating at the bottom (i.e. basements and crawlspaces) and at the top (i.e. attics and roofs) of a house should be prioritized, and these areas are also often the easiest to access in unfinished spaces.

Air Sealing

To start, sealing all of the large holes in the house will have the biggest effect. Plumbing, duct work, chimney chases, electrical work, and other service penetrations not intended for airflow or venting should be sealed where possible, no matter where they are in the house. It may seem obvious, but service penetrations are usually the leakiest areas of a house.

Once the large holes are sealed, the focus can be shifted to smaller, less obvious holes. At the basement or crawlspace, the rim joists should be sealed where the exterior wall meets the rim joist, and where the rim joist meets the foundation, as these areas can allow significant amounts of air into the home. Since cold air is drawn through these areas, air sealing can improve the thermal comfort of the home, and decrease heating costs.

Insulating

Where possible, the whole house should be insulated using standard practice insulating techniques to increase the thermal efficiency of the home. Insulation work must be done without compromising the durability of the existing wood-frame structure by creating a risk of condensation, high relative humidity conditions, or moisture entrapment. All insulation work begins with air sealing. Never insulate a wall, roof, or floor without first making sure the air leaks in the vicinity are addressed.

Typically, the attic and exposed floors, followed by the crawlspace, are the most cost-effective locations to perform insulating work. Unfinished basements are also easy to insulate. Insulating above- and below-grade finished walls is much more involved and is often better to perform at the time of other renovations, repairs or cladding work.

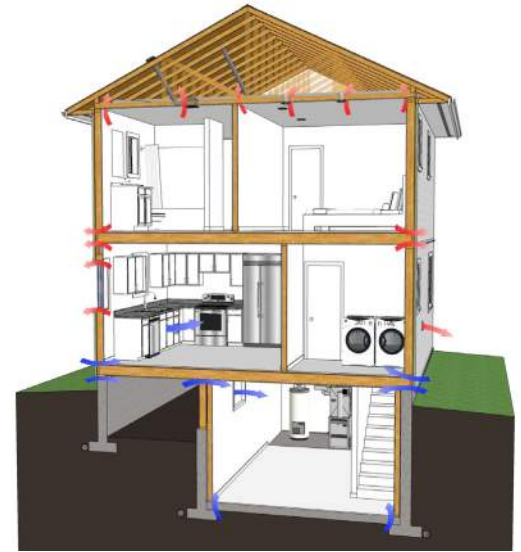

Schematic of a typical two-storey wood-frame house over a basement and crawlspace with a ventilated attic roof. Arrows show typical air leakage locations to review and address during weatherization work.

Energy Performance Assessment

An energy performance assessment should be conducted prior to performing weatherization work to determine the suitability of the house for improvements and to prioritize different energy efficiency measures. Additionally, this assessment — in conjunction with a post-retrofit assessment — can provide detailed information regarding the effectiveness of the weatherization measures. In some cases, this secondary assessment may also qualify a house for rebates as part of utility or government incentive programs.

While it can be difficult to economically justify individual weatherization measures, the costs of these measures are significantly lower when implemented as part of previously planned renovation work, or when rebates are available. Cost effectiveness for the homeowner can also be more easily predicted when a thorough energy performance assessment is conducted prior to starting the upgrades.

An EnerGuide home evaluation provides a homeowner and contractors with detailed information on a house and also produces an EnerGuide rating, a standard measure of the home's energy performance that enables comparison to other houses. The rating is based on house and equipment energy efficiency, house location, and house size. EnerGuide ratings and typical airtightness levels are presented in the following table for various house types. Additional information on the EnerGuide rating system is available at oe.nrcan.gc.ca.

Steps for effective use of energy performance assessments in the weatherization process:

- 1. Assess the house prior to weatherization:** An energy assessment professional such as an Energy Advisor should conduct an energy assessment of the house prior to weatherization work. The assessment should include the entire building enclosure, including insulation, windows, and doors, as well as the heating, cooling, ventilation and hot water systems. It should also include a whole-building airtightness test, often referred to as "blower door testing", to measure the airtightness. Additional testing to help identify air leakage paths is commonly done by the contractor or other consultants if needed. This can be done during blower door testing, or by using fans in the home to create the adequate pressure difference to produce airflow. Finally, the assessor should model the energy consumption of the house and generate the EnerGuide rating.
- 2. Implement weatherization measures:** Based on the assessment of the house, high priority weatherization (energy efficiency) measures such as air sealing and insulating should be implemented.
- 3. Assess the house after weatherization:** An energy assessment professional should conduct a follow-up assessment of the house. This assessment should confirm implementation of the selected energy efficiency measures. The assessments before and after weatherization confirm the effectiveness of the energy efficiency measures and can be used to apply for rebates.

EnerGuide Ratings and Airtightness Levels for Various House Types

Type of House	Typical EnerGuide Rating (GJ/year consumed rating, lower is better)	Typical Airtightness (ACH ₅₀ , lower is better)
Zero Energy House	0	<0.6
Energy Efficient House	45	0.6 to 4
New House	90	4 to 6
Built 1980 to 2010	110	6 to 8
Built 1960 to 1979	130	8 to 10
Built Before 1960	140	>10

Evaluating Air Sealing Needs

Home-specific air leakage evaluations should always be completed prior to energy retrofit work in order to focus air sealing efforts and get the best savings for the investment. No two buildings are exactly the same and the air leakage locations may differ substantially across similar buildings. A number of visual techniques and test procedures can be utilized to identify the size, location, and distribution of air leaks in a building.

Whole-Building Airtightness Testing

An Energy Advisor or other certified professional can conduct whole-building air leakage testing by pressurizing and/or depressurizing the building using a large calibrated fan. A blower door system, as the fan system is often called, is temporarily installed into an exterior door and the rate of air leakage through the building is measured. The resulting air leakage value, measured in air changes per hour (ACH) and equivalent leakage area (ELA), can be utilized to determine air sealing opportunities. Generally, a large ACH or ELA indicates that there are significant air sealing opportunities that can be addressed. It should be noted that while air leakage testing can provide quantitative information on the leakiness of a building, further test methods and observations are needed to establish the exact location of air leaks. A follow-up airtightness test can be completed after the retrofit is completed to gauge the effectiveness of completed air sealing measures.

Infrared Thermography

An infrared camera can be utilized to pinpoint air leakage and thermal bridging locations by providing a thermal image that contrasts temperature differences across the building enclosure. Areas that are warmer are usually represented by brighter colours, while areas that are cooler are represented by darker colours. Air leakage and thermal bridging locations will appear darker than surrounding elements if the image is taken from inside the building enclosure. The infrared images might identify several common areas that should be addressed with improved air sealing in order to reduce heat loss. Infrared thermography is most effective when completed during building airtightness testing.

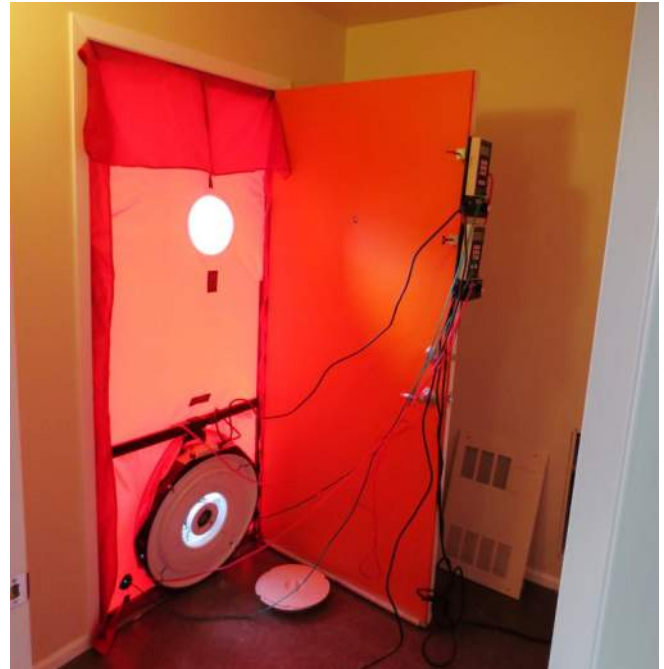

Typical blower door system installed in door frame for whole building airtightness testing.

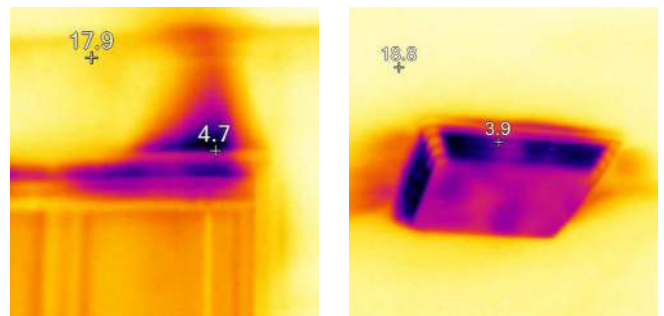

Infrared Thermography indicating air leakage at a window head (left), and showing a cold bathroom fan (right).



Smoke from smoke pencil being pulled through the wall indicating air leakage location.



Visible crack on the interior finishes indicating possible air leakage location.

Smoke Pencils or Puffers

Tracer smoke can be used to visually observe air leakage at problematic locations. When there are discontinuities in the air barrier, smoke will follow air movement through cracks and gaps in the building enclosure. Smoke testing is best completed at the same time as a whole-building airtightness test, but in some cases could also be completed using the exhaust fans in the home to create pressure difference across the enclosure. Air leaks can then be more easily observed on the exterior of the building.

Visual Inspection

Many air leakage locations can be discovered by completing a thorough visual inspection of the building interior, particularly at interfaces and penetrations. Common problem areas usually include dropped ceilings and window and door weather stripping and gaskets. Generally, air leakage locations appear as gaps or cracks in building walls, floors, or ceilings. Drafts or cold spots experienced near the building enclosure may also indicate problem areas.

Note

While some air leaks can be identified visually, under most circumstances it is recommended that a professional be hired to complete comprehensive air leakage testing. This guide will address several common air leakage locations as well as techniques that may be utilized to reduce air leakage at problematic locations. It should be noted that the most cost-effective air sealing measures are easily accessible and do not involve removing other building components. In practice, this often means air sealing interior details such as gaps in the interior finishes like gypsum wall board as opposed to air sealing the air barrier system that might exist far behind interior or exterior finishes.

Determining Assembly & Component Upgrades

Exterior Retrofit

When high thermal performance is desired, and an interior retrofit is intrusive or impractical. This is also the most durable approach as exterior insulation results in less risk of moisture damage within the enclosure.

Interior Retrofit

When high thermal performance is desired, and where an exterior retrofit is impractical or not possible due to property setbacks.

Accessible Attic

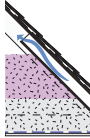

Insulation top-up

Air seal from within the attic space

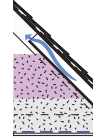

Insulation top-up

Air seal from within the attic space

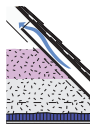

Flash and fill

A continuous air barrier is installed in the attic

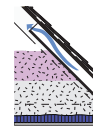

Flash and fill

A continuous air barrier is installed in the attic

Vaulted/Flat Ceiling

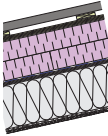

Insulation added to the exterior

New air barrier installed on the exterior

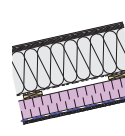

Insulation added to the interior

New air barrier installed on the interior

Above-Grade Walls

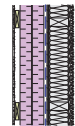

Insulation added to the exterior

New air barrier installed on the exterior



Insulation added to the interior

New air barrier installed on the interior

Exposed Floors

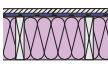

Insulation installed in empty joist cavities

Air seal from below

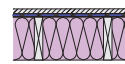

Insulation installed in empty joist cavities

Air seal from below

Below-Grade Walls

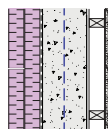

In combination with foundation work insulation is added to the exterior of the wall. The concrete wall is the air barrier—ensure air barrier continuity between foundation wall and wood framing

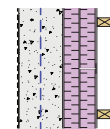

Insulation is added to the interior

Tape and seal interior foam insulation board—this lowers the risk of condensation on the concrete wall

Crawlspaces

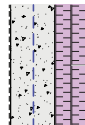

Convert the crawlspace to an unvented and insulated space

Air seal walls and crawlspace floor

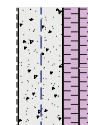

Convert the crawlspace to an unvented and insulated space

Air seal walls and crawlspace floor

Windows and Doors

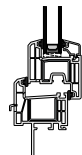



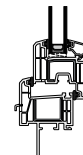

Replace with high thermal performance windows and doors. See [Additional Resources](#) on page 84 for guidance on replacement considerations and installation procedures

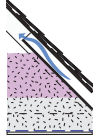
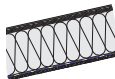
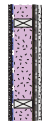
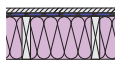

Replace with high thermal performance windows and doors. See [Additional Resources](#) on page 84 for guidance on replacement considerations and installation procedures

Insulation Top Up

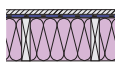
For small budgets, or where neither interior or exterior retrofits are possible.

Accessible Attic		<p>Insulation top-up</p> <p>Air seal from within the attic space</p>
Vaulted/Flat Ceiling		<p>N/A</p> <p>Seal air leakage points from the interior</p>
Above Grade Walls		<p>N/A (unless there is no existing insulation)</p> <p>Seal air leakage from the interior</p>
Exposed Floors		<p>Insulation installed in empty joist cavities</p> <p>Air seal from below</p>
Below Grade Walls		<p>N/A</p> <p>Seal air leakage points from the interior</p>
Crawlspace Ceilings		<p>Insulation installed in empty joist cavities</p> <p>Air seal from below during insulation work</p>
Windows and Doors		<p>Retain windows and air seal as viable.</p>

Retrofit Procedures

This section provides step-by-step procedures for air sealing and insulation work. Where the work is more complex and beyond the scope of this guide (such as full house exterior wall insulating), less detailed conceptual-level procedures are provided. For these larger-scale measures, typically a building enclosure design will need to be performed by a home designer, architect, engineer, or contractor.

Each procedure contains a list of the necessary materials and tools along with a step-by-step description of the work. It may also be possible to use alternate materials, as long as the intended performance is maintained. Contractors should also refer to the health and safety checklist provided in [Section 5](#) on page 87.

The information presented in this section is as follows:

- Thorough coverage of accessible attic air sealing and insulation measures, typically the easiest and most cost effective to perform as part of weatherization efforts.
- Attic insulation upgrades, and air sealing and insulation options for cathedral ceilings, which are more difficult to seal or insulate without significant interior or exterior construction work.
- Below-grade walls and crawlspaces are discussed in detail, as they are accessible and relatively easy to air seal and insulate.
- Exposed floor solutions are covered.
- Above-grade wall air sealing and insulation procedures are only briefly discussed, as weatherization projects do not typically include this intensive and disruptive work. Additional references and recommended solutions are provided to assist with these projects.

For each of these procedures, it is important that air sealing work always be performed prior to insulating to prevent condensation and moisture-related problems caused by the added or upgraded insulation.

Where more extensive work is planned such as window replacement or wall and roof upgrades, or where home renovation work is planned in conjunction with building enclosure upgrades, homeowners should consider consulting design professionals.

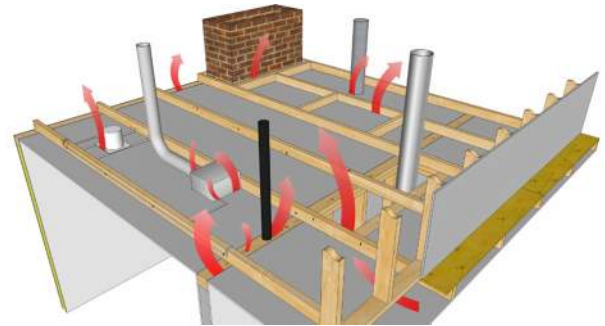

Attic air sealing locations.

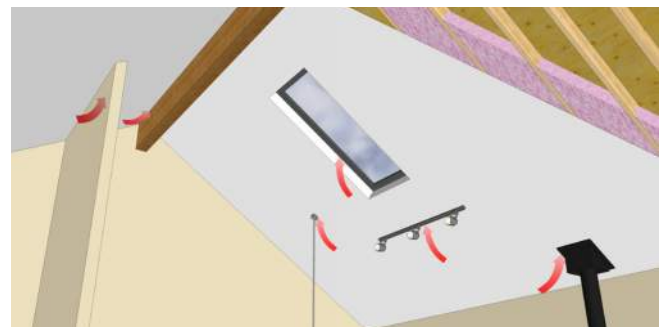

Cathedral ceiling air sealing locations.



Above-grade wall air sealing locations.

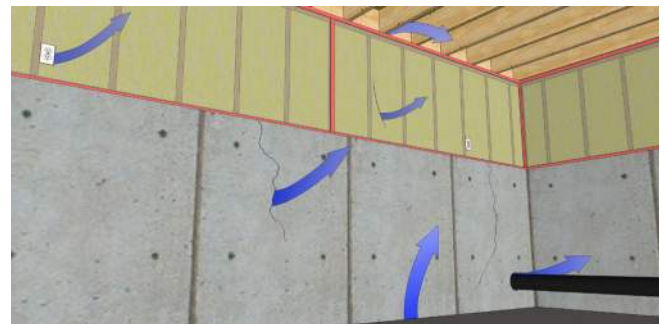

Below-grade wall air sealing locations.

List of Procedures

Accessible Attic Ceiling Spaces

Air Sealing Considerations	18
1 Recessed Pot/Can Light	20
2 Attic Hatch	23
3 Bathroom Fan and Duct	26
4 Kitchen Range, Dryer, or Other Exhaust Duct	28
5 Fireplace or Other Combustion Appliance Vent	30
6 Wall Top Plate and Plumbing/Electrical Penetrations	32
7 Large Openings, Shafts, or Drop Ceilings	34
8 Attic Knee Walls	36
9 Ceiling Perimeter and Gable End Walls	38
10 Masonry Chimney	40
Insulation Considerations	42
11 Topping Up Existing Insulation	44
12 Flash-and-Fill Insulation	46

Inaccessible Attics and Vaulted/Flat Ceilings

Air Sealing Considerations	48
Insulation Considerations	49
13 Interior Retrofit	50
14 Exterior Retrofit	51

Above Grade Walls

Air Sealing Considerations - Interior Approach	52
Air Sealing Considerations for Exterior Washroom Walls	53
15 Exhaust Vents Through Walls and Soffits	54
16 Stud Bay Blown-in Insulation Retrofit	56
Considerations for Interior and Exterior Retrofits	58
17 Interior Retrofit	59
18 Exterior Retrofit	60

Exposed Floors

19 Overhanging Floors	64
20 Protected Porches Over Living Space	66

Below-Grade Walls

Typical Air Sealing Locations	68
Interior Versus Exterior Insulation	69
21 Interior Approach	70
22 Exterior Approach	72

Crawlspaces

23 Suspended Floors Over Crawlspaces	74
24 Vented to Unvented Crawlspace Conversions	76
25 Floors and Slabs on Grade	78

Windows and Doors

Air Sealing Considerations for Accessible Attic Ceiling Spaces

All attic/ceiling energy-efficiency measures begin with some ceiling plane air sealing work followed by insulation top-ups or replacement. With proper preparation, air sealing spray foam insulation may be used for both purposes. To ensure adequate adhesion when using sealants or spray foam for air sealing, clean all areas requiring adhesion. Guidance is provided here to first seal all common ceiling penetrations and interfaces and then to upgrade insulation levels. Additional procedures and a good companion document for the work is the *Guide to Attic Air Sealing* by the Building Science Corporation (see [Additional Resources](#) on page 84).

BEFORE YOU START

Do Not Proceed If:

- The attic has active knob-and-tube wiring.
- The attic has vermiculite insulation.
- Bathroom or other exhaust fans are vented into the attic.
- The house has a leaking roof.
- The house has a fireplace with no means of accessing combustion makeup air after air sealing occurs.
- The house has significant moisture or mould issues.
- Active radiant ceiling panels are present in the attic.

Important Notes:

Soffit, ridge, and gable vents are all intentional openings that must be kept open for ventilation. They should not be sealed.

Only use the joists and rafters to move around on. Do not step on the ceiling.

Storage in the attic is discouraged because of the risk of compressing the insulation and reducing the insulation R-Value. If storage is planned, a platform should be constructed above the insulation to hold storage items without compressing the insulation.



Accessible attic with trusses, batt insulation, and a masonry chimney.



Accessible attic with potential air leakage around the plumbing stack penetration through the ceiling.



Above is an example of a poorly installed pot light where no measure of air sealing has been taken.

Typical Air Sealing Locations in Accessible Attic Ceiling Spaces:

- | | |
|--|---|
| 1 Recessed Pot/Can Light | 6 Wall Top Plate and Plumbing/Electrical Penetrations |
| 2 Attic Hatch | 7 Large Openings, Shafts, or Drop Ceilings |
| 3 Bathroom Fan and Duct | 8 Attic Knee Walls |
| 4 Kitchen Range, Dryer, or Other Exhaust Duct | 9 Ceiling Perimeter and Gable End Walls |
| 5 Fireplace or Other Combustion Appliance Vent | 10 Masonry Chimney |

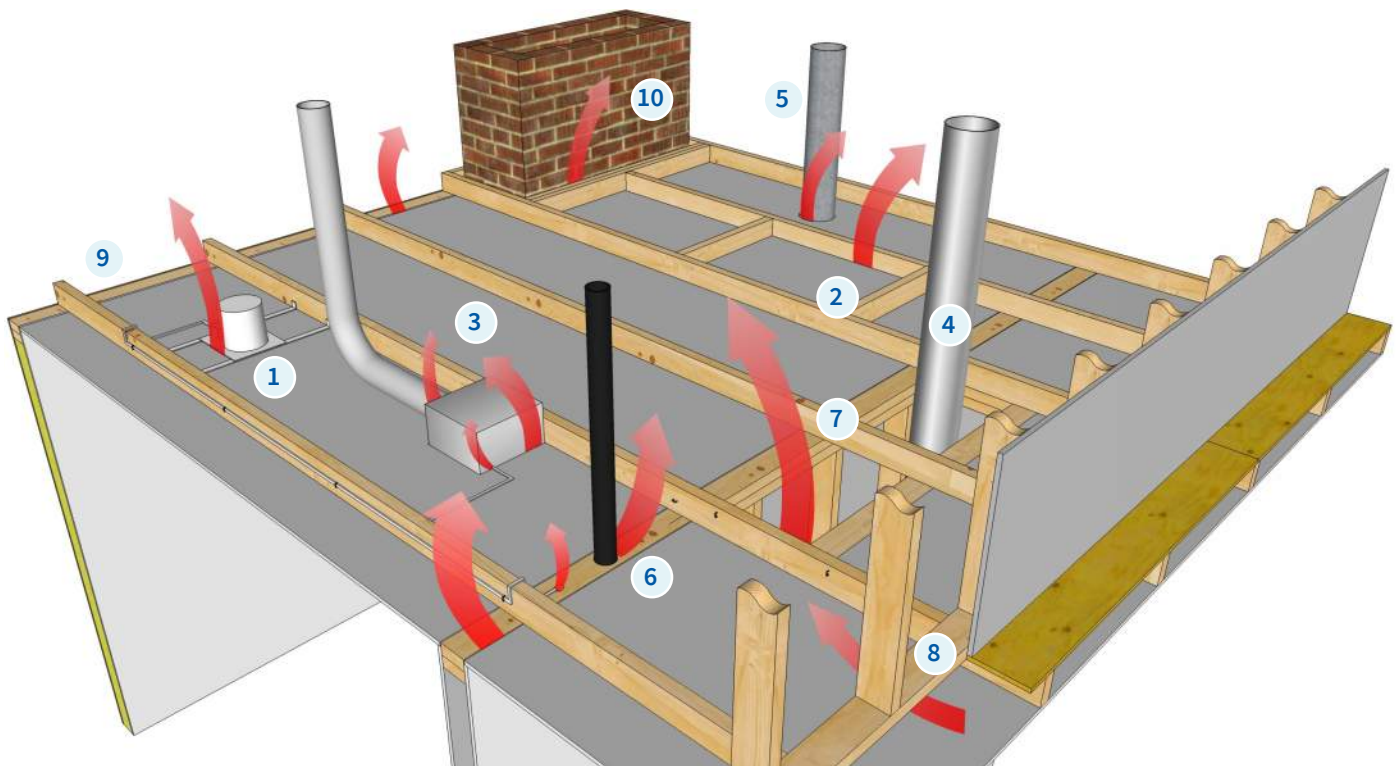

1 | Recessed Pot/Can Light

Recessed pot lights (also called can lights) are one of the most common air leakage points through the ceiling plane into the attic. Air leakage occurs between the housing and the ceiling air barrier (either the polyethylene sheet, if present, or the interior finish) and through the fixtures' housing holes and its electrical connections. Currently, light fixtures are available with or without ratings for insulation contact (IC) and airtightness (AT). Most new homes will utilize IC/AT-rated fixtures, and most older homes utilize non-IC/AT-rated fixtures. IC-rated fixtures allow for direct contact with insulation (up to 8" deep) whereas non-IC-rated fixtures require no insulation to be within up to 3" of all sides and the top to allow for heat dissipation.

The first procedure is for leaky non-IC-rated pot lights. A similar procedure could also be followed for leaky IC-rated pot lights. If the light housing is airtight and has been properly sealed to the ceiling air barrier, this procedure is not required. Proprietary fire-rated airtight housing covers are also available, and may simplify this procedure.

The second procedure is for replacing non-IC-rated pot lights with IC- and AT-rated replacement fixtures. Replacing existing pot lights with IC/AT fixtures is recommended, as it simplifies and improves the ceiling air sealing and insulation procedures.

Items to Avoid

- Do not cover the top of the box with insulation after enclosing an existing non-IC-rated pot light. The box should be left uncovered so that heat can dissipate from the pot light fixture. Only IC-rated fixtures can be covered with insulation.
- Do not use spray foam directly in contact with electrical fixtures or uninsulated wires.

Items to Incorporate

- When enclosing an existing non-IC-rated pot light, make sure the minimum clearance between the pot-light housing and the drywall box is 3 inches.
- Ensure all electrical wires are properly attached to the fixture and secured to the framing, and that the penetrations through the box are sealed. The use of an electrician is recommended for replacing any light fixtures.

Materials/Tools Needed

- Gypsum board/sheathing
- Polyurethane sealant
- Sheathing tape

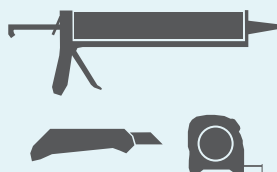

Boxing out existing non-IC-rated pot lights mitigates air leakage at these locations.



LED pot lights are IC- and IT-rated, and many models are safe to use in wet environments such as showers.

Homeowner Tips

Consider replacing existing light bulbs with compact fluorescent bulbs or LED lamps to reduce heat build-up and save electrical energy.

Procedure: Retaining Non-IC-rated Recessed Pot/Can Lights

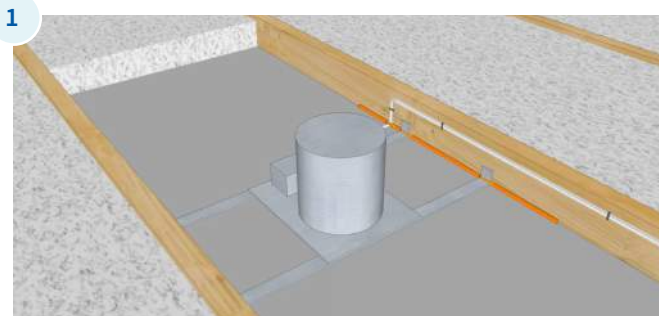

Expose the ceiling finish approximately 12" on both sides of the pot light. Add sealant at the joist-to-gypsum board joint, extending past the ends of the gypsum board box to seal the gap between the joist and drywall (or polyethylene sheet, if present).

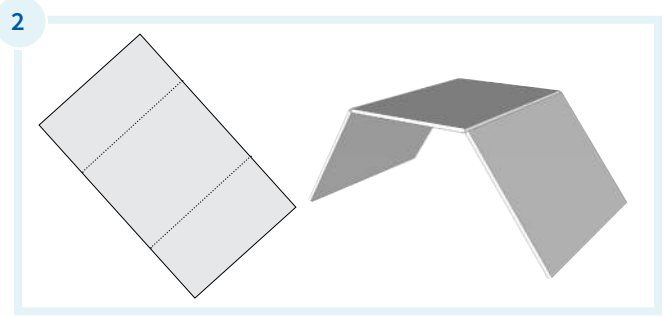

Create the boxes outside the attic. Precut a piece of drywall 42" long by 22 1/2" wide (for 24" ceiling joist spacing) or 14 1/2" wide (for 16" ceiling joist spacing). Score the back side of the gypsum board at 12" from ends. Break along lines and form an inverted U-shape of gypsum. Cut two gypsum board end closures, 18" long by 8.5" wide.

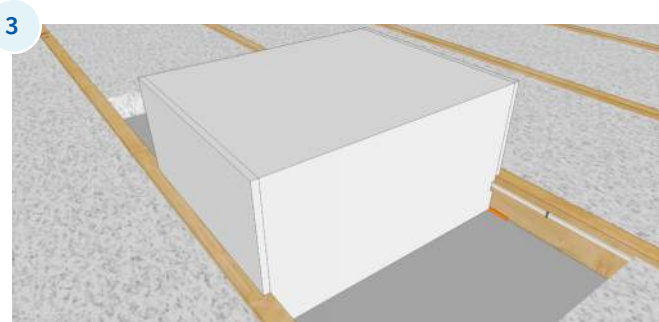

Install the gypsum board box in the attic between the ceiling joists. Notch the drywall box to fit around wiring and other framing etc. Install the gypsum board end closures.

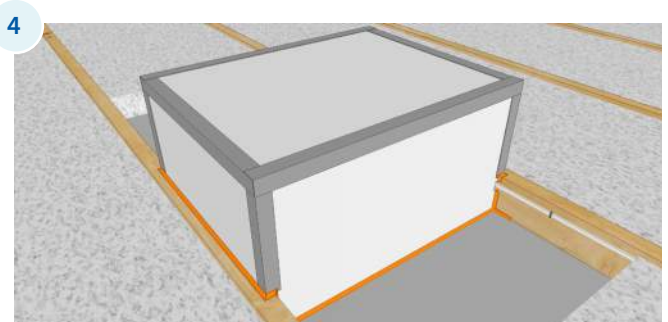

Tape seams of the gypsum board box. Seal the box to the ceiling (or polyethylene sheet, if present) with sealant and fill notches and gaps with sealant. Inspect the box to ensure all gaps and joints are taped/sealed and airtight.

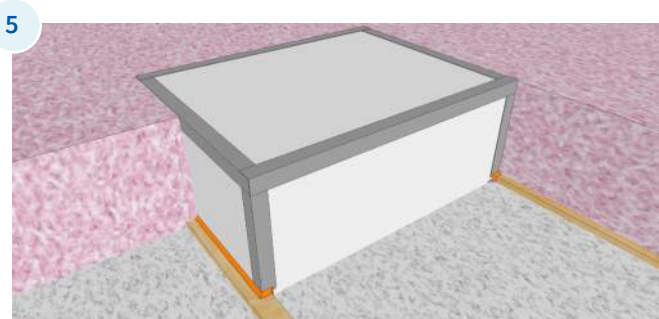

Replace the existing insulation around the sides. Insulation should not be placed on top of the box.

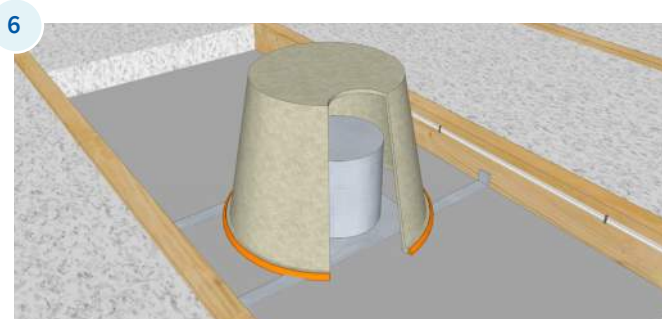

Alternatively, consider using a manufactured pot light cover, sealing around the edges and at the wire and mounting penetrations with sealant. Ensure the required distances from the pot light housing are maintained within the cover.

Procedure: Replacing Non-IC-rated Pot/Can Lights with IC/AT-rated Fixtures

1



Materials/Tools Needed

- Polyurethane sealant if the fixture has no air seal gasket



Choose replacement fixture. IC/AT-rated replacement housings (left) come in different configurations and sizes. Trim to cover the housing is often purchased separately. LED pot lights (right) are easy to install, and energy efficient.

2

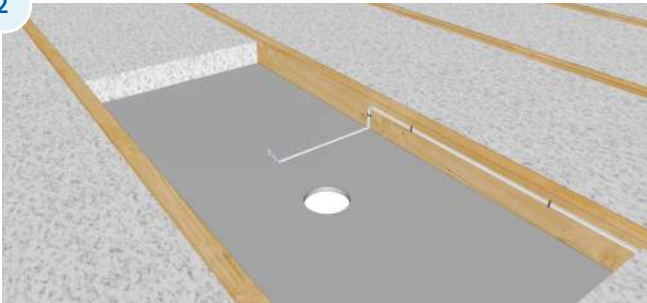

Remove existing insulation around the area of work. Disconnect and remove existing non-IC-rated pot light. Cut or repair the ceiling as needed if the diameter of the new pot light is different.

3

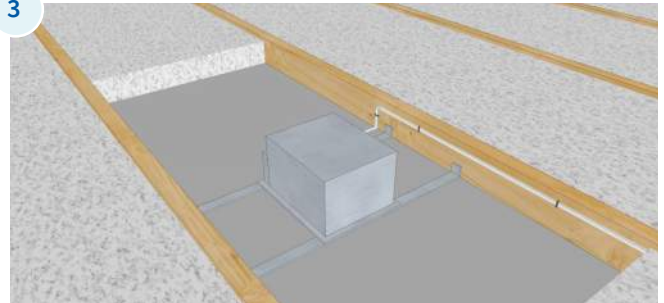

Install new IC/AT-rated pot light. (IC/AT-rated replacement housing is shown.)

4

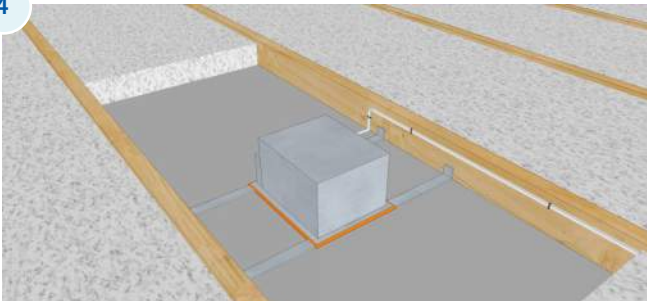

An IC/AT-rated pot light may come with gaskets to provide a seal between the housing and the drywall. Seal around penetrations as needed.

5

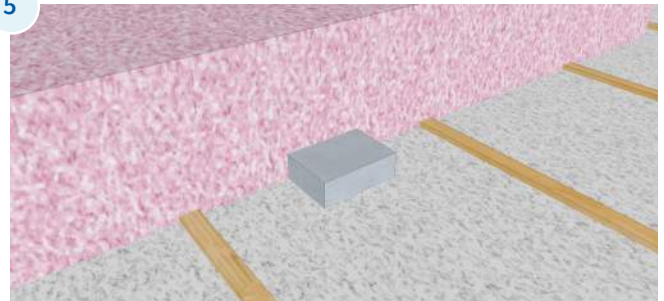

Replace the insulation and add new insulation as desired.

2 | Attic Hatch

Attic hatches can often be overlooked for air sealing work. They present a unique challenge, because the hatch has to be airtight while still allowing access to the attic. Air leakage occurs through the joint between the hatch and the ceiling. The hatch is most often a piece of gypsum board cut to size, resting on a ledge made from wood trim or resting in the edge of the ceiling drywall inside the opening.

These air sealing procedures are for hatches that rest on the ceiling gypsum or wood-trimmed ledge. In order to achieve an effective air seal, it is important to ensure that the existing hatch is sized properly so that it has enough contact with the opening ledge.

If the attic hatch has a built-in attic access ladder on the top side, additional insulation cannot be easily placed on the hatch. The hatch can remain uninsulated, but attention must be paid to the perimeter seals. Ensure the attic hatch sits tightly against the opening seals and keeps an airtight seal when not in use.

Items to Avoid

- Do not size the rigid insulation on the attic hatch to fit too closely against the surrounding framing.
- Do not place heavy items on the hatch to weigh it down onto the gasket.

Items to Incorporate

- Ensure the attic hatch is fully engaging the edge gasket. If needed, install a latch or hooks on the edge of the hatch to hold it firmly down.
- Build the insulation guard so that access to the hatch is not impeded and it will remain intact with continued passage into the attic.



An access hatch with an insulated gypsum access cover.



An attic access cover made from plywood resting on a wood-trimmed opening.

Materials/Tools Needed

- Extruded polystyrene and/ or batt insulation
- Self-adhered weather stripping
- Sheathing and framing lumber
- Screws or nails
- Adhesive

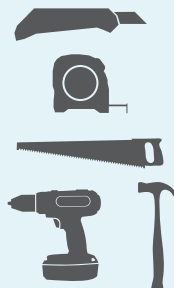

Homeowner Tips

Be careful when entering the attic. Use a flashlight/ headlamp or ensure there is enough light inside the attic to safely enter. Watch for obstructions such as overhead truss members or nails.

Ensure the hatch is properly seated on the gasket when closing the hatch.

Procedure: Attic Hatch (Regular Passage Expected)

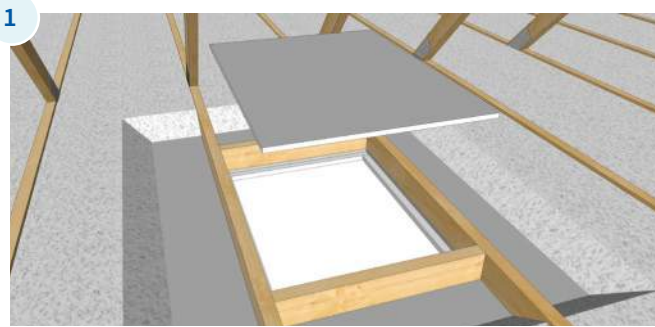

Expose the ceiling finish approximately 12” on all sides of the attic access hatch.

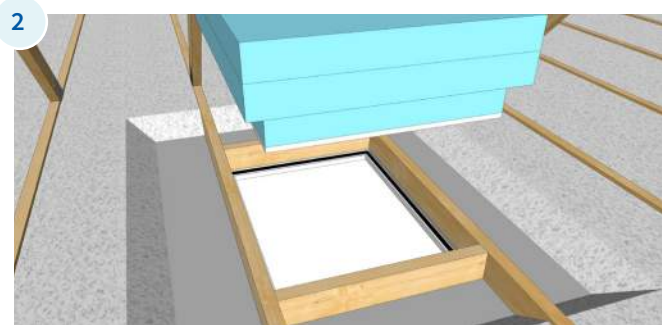

Cut two pieces (or more) of rigid foam to adhere to the access cover. Size the rigid foam so there is a layer adhered to the access hatch that fits within the opening joist space and there is a layer of foam that fits over top of the ceiling joists on all sides.

Adhere weather stripping to the ledge of the access opening on all sides.

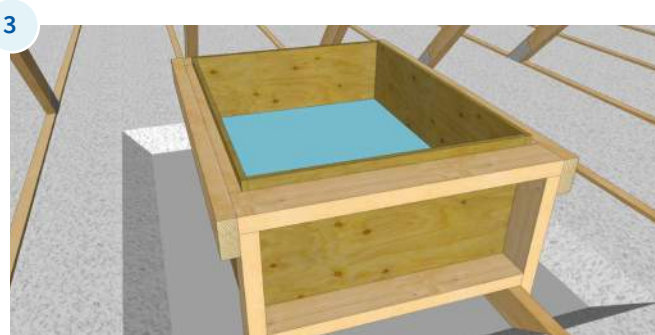

Install plywood or OSB box around the opening. Size the box so that the top edge is above the additional insulation level. Notch it to fit around joists and other framing and use additional framing to reinforce the box.

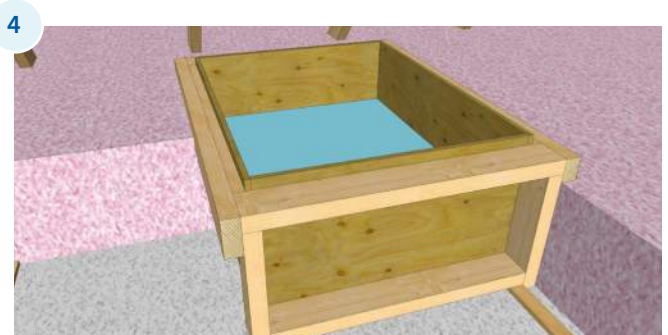

Replace existing insulation and install additional insulation around the box.

Ensuring a proper air seal

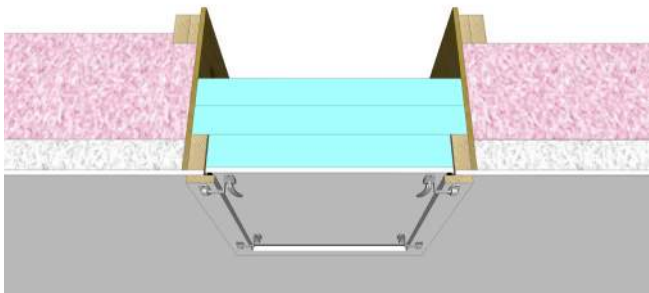

Use latches around the attic hatch perimeter to ensure engagement of the edge gasket.

Procedure: Attic Hatch (Minimal Attic Access Expected)

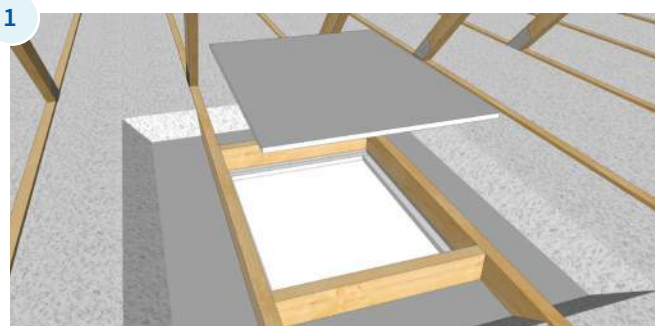

1 Expose the ceiling finish approximately 12” on all sides of the attic access hatch.

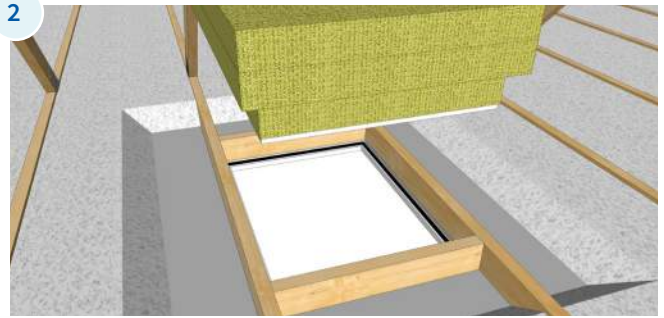

2 Cut batt insulation and adhere to the access cover. Size the batt insulation to fit within the opening joist space and over the top of the ceiling joists on all sides.

Adhere weather stripping to the ledge of the access opening on all sides.

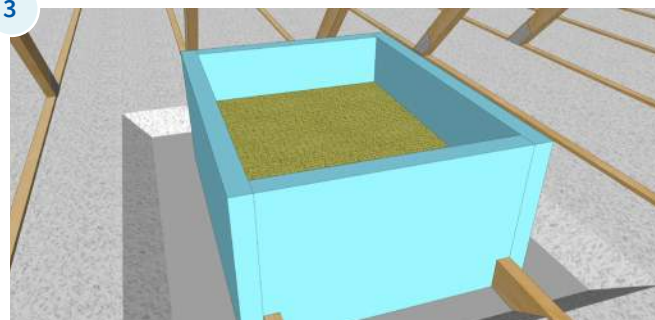

3 Install rigid insulation around the opening. Size the rigid insulation so that the top edge is above the additional insulation level. Notch it to fit around joists and other framing.

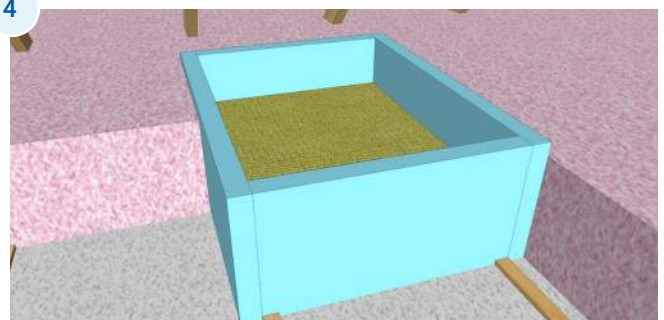

4 Replace existing insulation and install additional insulation around the rigid insulation.

Ensuring a proper air seal

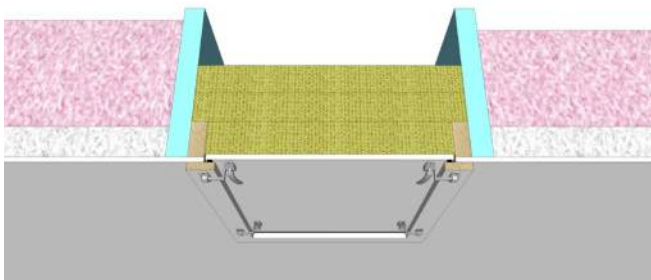

Use latches around the attic hatch perimeter to ensure engagement of the edge gasket.

3 | Bathroom Fan and Duct

Bathroom exhaust fan housings and duct connections are common air leakage points through the ceiling plane into the attic. Air leakage occurs between the housing and the drywall (and polyethylene sheet, if present) and through the fixture housing holes and electrical connections. Air leakage can also occur at the duct connection into the housing. It is important to seal this connection to stop warm, moist air from venting into the attic.

This procedure is for exhaust fans mounted to the side of a joist. If the exhaust fan is mounted in the middle of the joist space, the procedure can be adjusted accordingly. Ensure the duct is insulated the whole length of the attic. If it is not, install a 2" thick (minimum) insulation sleeve (see procedure 4 | [Kitchen Range, Dryer, or Other Exhaust Duct](#) on page 28).

Items to Avoid

- Do not attempt to directly seal or alter the fan housing.
- Do not make electrical repairs without consulting an electrician.

Items to Incorporate

- Always make sure power is shut off at the breaker before working with wiring.
- Ensure the exhaust duct is sealed, insulated, and not collapsed, throughout the whole attic space.
- Ensure all electrical wires are properly attached to the fan and secured to the framing. If they are not, consult an electrician.



Bathroom exhaust fan venting into the attic. Conditions such as this should be remedied prior to or as part of air sealing and insulation work.

Materials/Tools Needed

- Spray foam (spray can or two-part) and/or polyurethane sealant
- Extruded polystyrene (or gypsum board)
- Sheathing or foil tape

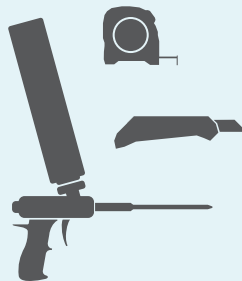

Homeowner Tips

Keep the exhaust fan clean to ensure adequate ventilation. Use a vacuum or duster to regularly clean the fan and inside the housing.

Consider replacing an old and noisy bathroom fan with a new quieter and more energy-efficient model at the time of this work. Look for a fan that is Energy Star® qualified with a noise level of less than one sone.

Procedure: Bathroom Fan and Duct

1

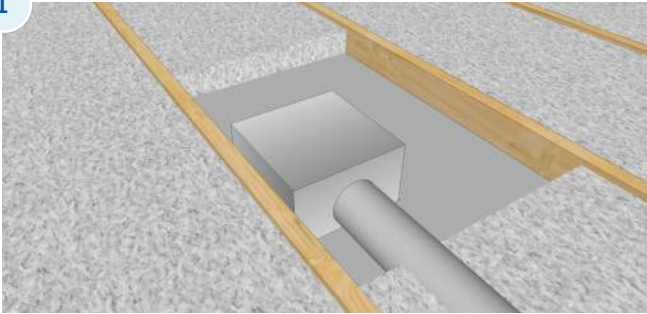

Expose the ceiling finish approximately 12" on both sides of the fan housing.

If the bathroom fan is mounted to the side of a ceiling joist (as shown) it may be beneficial to temporarily move the housing out of the way in order to seal the joist to gypsum board joint (see 1 | [Recessed Pot/Can Light](#) on page 20).

2

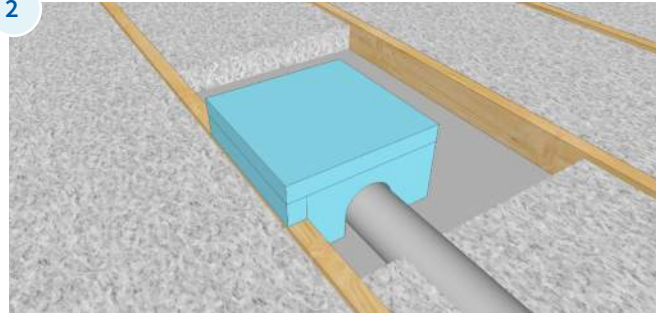

Create a five-sided box with extruded polystyrene to fit over the fan housing leaving a minimum 1/2" clearance around the housing. Cut access in the box for the exhaust duct outlet.

3

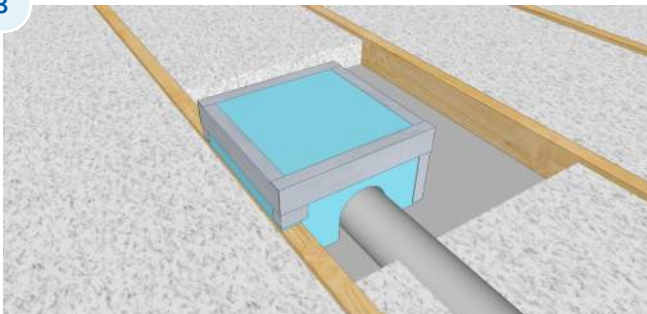

Seal all edges of the insulation enclosure with sheathing tape or foil tape.

4

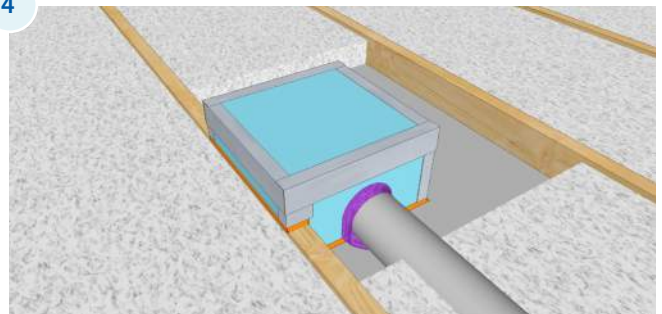

Seal the enclosure to the ceiling gypsum board and joists with sealant.

Seal around the duct penetration and other notches with spray foam.

5

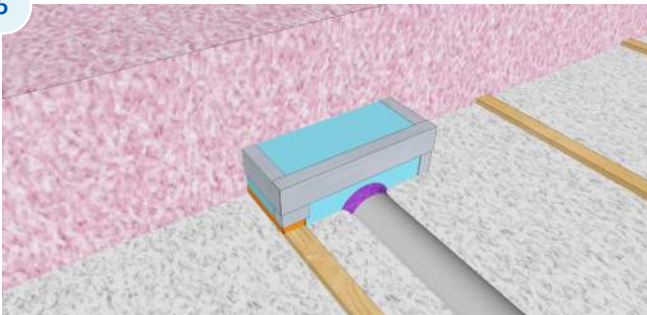

Replace existing insulation and install additional insulation.

4 | Kitchen Range, Dryer, or Other Exhaust Duct

Kitchen range, dryer, bathroom fan, and other exhaust ducts that don't vent combustion air can be air sealed with relative ease. Besides making the ceiling penetration airtight, it is also important to air seal the duct itself to prevent warm, moist air from venting into the attic. All mechanical air ducts (both supply and exhaust) running through the attic should also be insulated in order to avoid condensation within the duct and reduce heat gain into the attic, which can be an issue in colder regions where it may contribute to ice damming. Flex duct that is not insulated should be replaced with insulated ducts, and rigid ducts should be covered with an insulation sleeve.

This air sealing procedure is for a range or other exhaust duct that penetrates the ceiling without a framed shaft.

Items to Avoid

- Do not use this air sealing procedure for vents that exhaust air from combustion appliances, or if you are unsure of what the duct is exhausting.

Items to Incorporate

- Ensure the outside of the exhaust duct is sealed, insulated, and is not collapsed, throughout the whole attic space.
- Ensure the spray foam or sealant at the ceiling penetration is even and continuous to create an airtight seal.
- Ensure connection of the duct to the exhaust boot or vent hood is properly sealed.



Uninsulated and un-sealed exhaust duct running through an attic, leaking air and heat to the space.



Insulated exhaust duct in attic.

Materials/Tools Needed

- Spray foam (spray can or two-part) and/or polyurethane sealant
- Foil tape
- Insulated duct sleeve (2" glass fibre insulation) with foil or plastic cover, or insulated flex duct sleeve

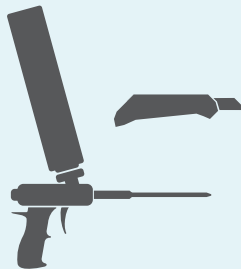

Homeowner Tips

Kitchen range and bathroom fans are used to remove moist air from the house. Ensure they are in use when cooking or using the shower.

Procedure: Kitchen Range, Dryer, or Other Exhaust Duct

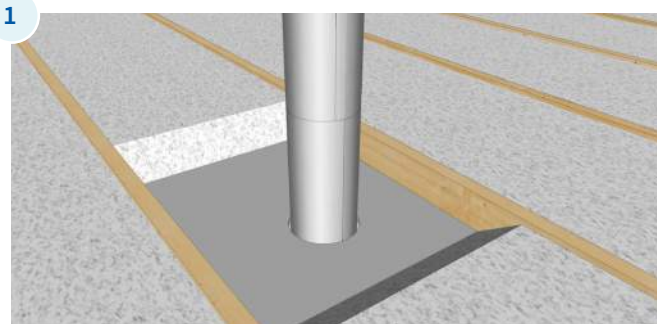

1 Expose the ceiling finish approximately 12" on both sides of the duct. Remove existing duct insulation if present and set aside for re-use.

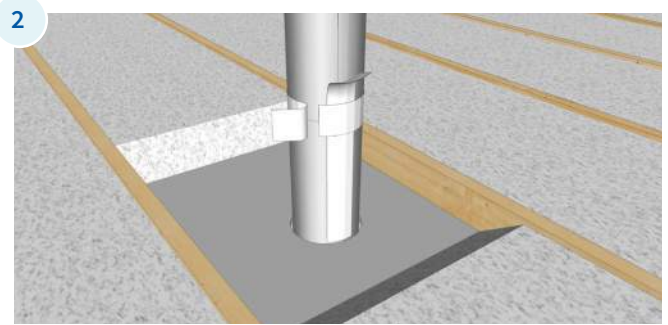

2 Install tape at joints and penetrations in the duct.

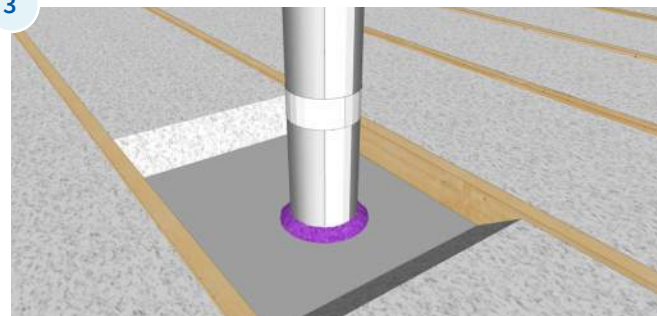

3 Install spray foam or sealant around the duct penetration at the ceiling finish.

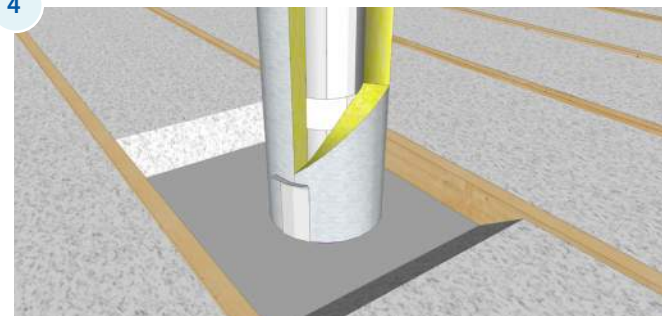

4 Install duct insulation or new insulation sleeve along the whole length of the duct inside the attic. The duct insulation should be at least 2" thick.

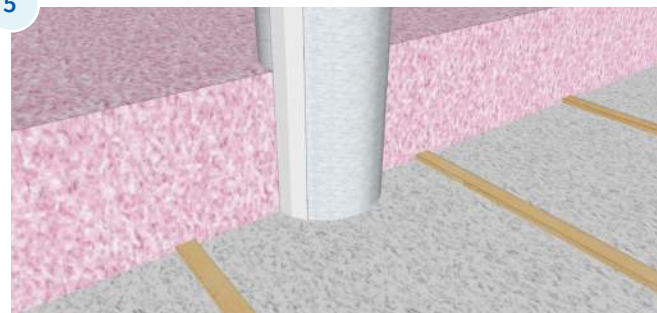

5 Replace existing insulation and, if desired, install additional insulation.

5 | Fireplace or Other Combustion Appliance Vent

Gas fireplace or other hot exhaust metal chimney/flue vent penetrations are a source of air leakage into attics. It is important to use only fireproof sealing materials at locations near or in contact with the chimney.

Fire-resistant silicone sealant is required where high temperatures are present. Do not place insulation or other building materials in contact with the metal chimney unless they are approved for that purpose. Do not alter the configuration of the metal chimney or other related components without talking to a professional heating, ventilation and air-conditioning (HVAC) contractor.

This air sealing procedure is for metal exhaust vents that extend through the ceiling into the attic space. Side-vented appliances are not addressed in this guide.

Items to Avoid

- Do not insulate a hot exhaust flue. Any work on a chimney should only be done with direction from an approved HVAC contractor.
- Do not cover the insulation guard with insulation

Items to Incorporate

- Ensure clearance between the chimney and all combustible building materials is 3", unless otherwise instructed by an approved HVAC contractor.
- Use only fireproof sealing material in contact with the chimney.



Metal chimney with sheet metal seal over ceiling joists.

Materials/Tools Needed

- Fire-resistant silicone sealant
- Sheet metal
- Circular metal duct (approx. 6" larger diameter than vent to be sealed)

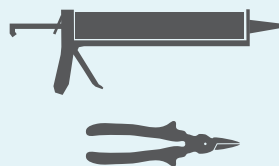

Homeowner Tips

If storage is planned in the attic, ensure that no items come in contact with the vent.

Procedure: Fireplace or Other Combustion Appliance Vent

1

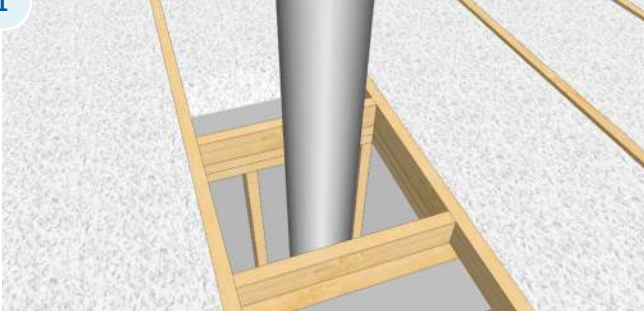

Expose the ceiling finish and framing on each side of the chimney chase. Install blocking as needed to create a four-sided framed box.

2

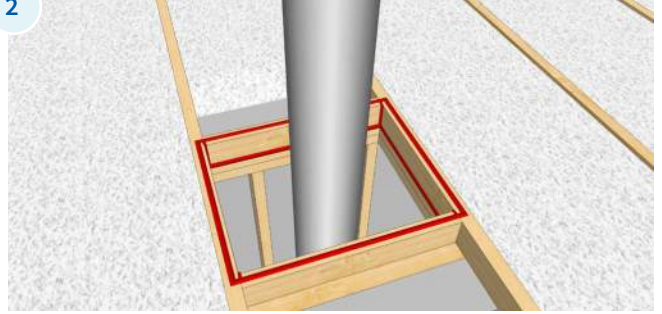

Install sealant around joists and blocking to seal the chase-wall framing to the joist framing and at the corners of the chase.

Install sealant along the top side of the joists and blocking in order to adhere and seal the sheet metal closure.

3

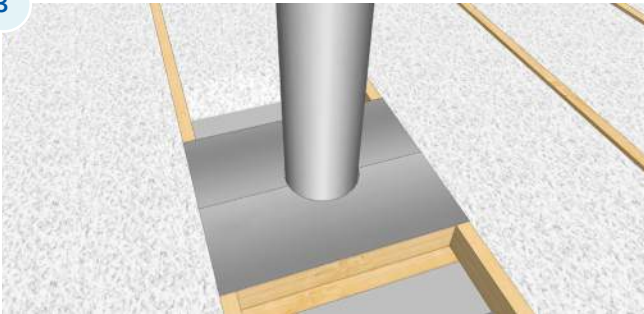

Cut and install the sheet metal closure to fit over the chimney opening tight to the metal chimney, with overlap at each joint. Apply sealant between the metal closures where they lap, and between the metal closures and wood framing. Secure the metal closures to the wood framing with screws.

4

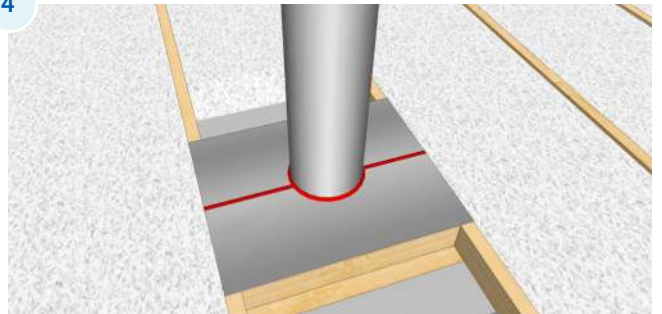

Seal the metal closure to the chimney and at each joint with silicone sealant.

5

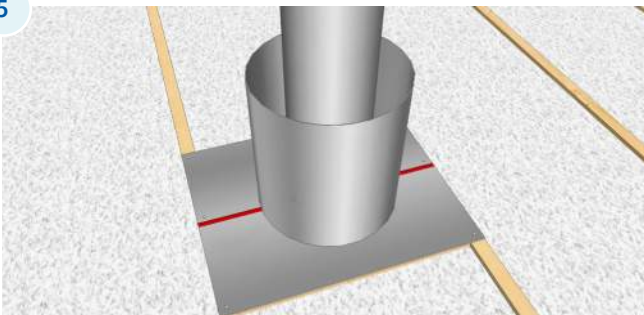

Install an insulation guard around chimney using an oversized metal duct. Cut and fold tabs to keep the insulation guard spaced 3" from the chimney on the top and bottom. Size it so that the top edge is above the insulation level, including any additional insulation that may be added.

6

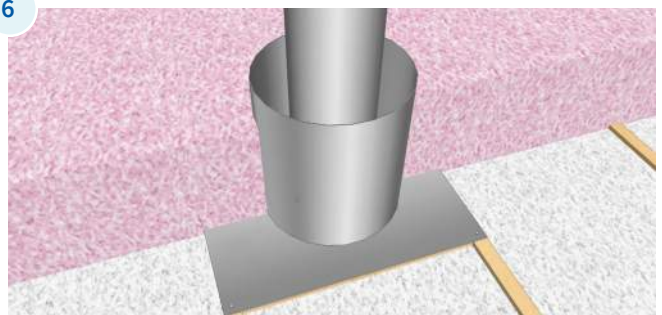

Replace existing insulation and install additional insulation around the chimney insulation guard.

6 | Wall Top Plate and Plumbing/Electrical Penetrations

Top plates of interior and exterior walls are a common point of air leakage. Minimizing air leakage at these locations, especially at the ceiling perimeter, is one of the most effective air-sealing strategies to improve the home's airtightness.

If the home has a polyethylene sheet at the ceiling level that is not detailed as an air barrier, it will allow air leakage at every location where the ceiling finish terminates. In addition, even with a polyethylene air barrier at the ceiling, service penetrations (e.g. electrical, plumbing) in the top plates of interior walls are often overlooked.

This air sealing procedure is for top plates without a properly detailed air barrier at the ceiling plane. This procedure is not required if a polyethylene sheet is in place and runs between the two top plates of the wall, though it may still apply to service penetrations.

Items to Avoid

- Do not use spray foam directly in contact with electrical fixtures or uninsulated wires.

Items to Incorporate

- Use a flexible air seal like a polyethylene sheet, rubber gasket, or flexible tape where movement is expected.
- Seal all penetrations with spray foam where no movement is expected. Ensure all surfaces are clean to achieve sealant adhesion.
- Use a fire-rated silicone sealant if sealing electrical boxes in the attic space.



Exposed interior top plate as viewed from the attic.



Spray foam installed over top plate joint.



Top plate penetrations sealed with spray foam.

Materials/Tools Needed

- Spray foam (spray can or two-part) and/or polyurethane sealant
- 10 mil polyethylene sheet or flexible gasket or tape
- Acoustic sealant



Homeowner Tips

If performing renovations where new wiring or plumbing stacks are added through the ceiling, ensure a similar procedure is followed for air sealing.

Procedure: Wall Top Plate and Plumbing/Electrical Penetrations

1

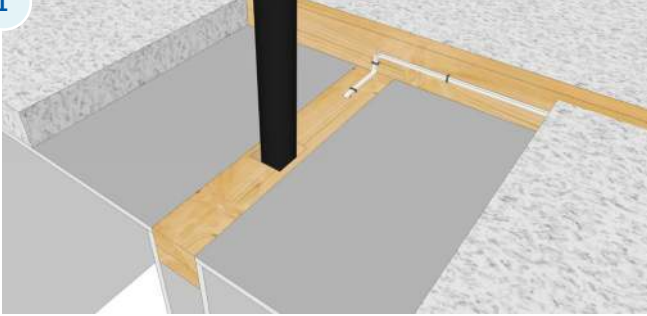

Expose the ceiling finish approximately 12" on both sides of the top plate. Clean area with brush or vacuum to ensure adequate sealant adhesion.

2

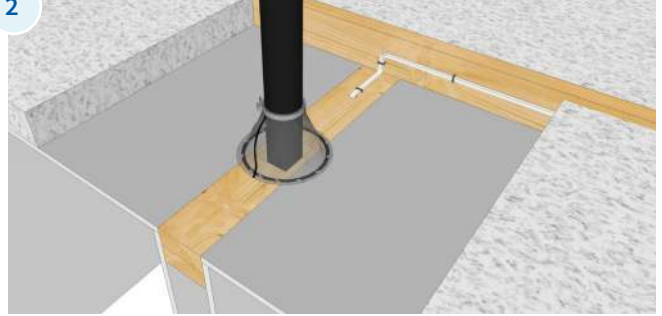

Install flexible gasket or polyethylene sheet around larger penetrations such as plumbing stacks. Seal it with acoustical sealant, staple it to the ceiling, and clamp it to the vent stack with a pipe clamp. Alternatively, use high-performance flexible tape. This flexible air seal is to accommodate thermal movement of the plastic vent pipe.

3

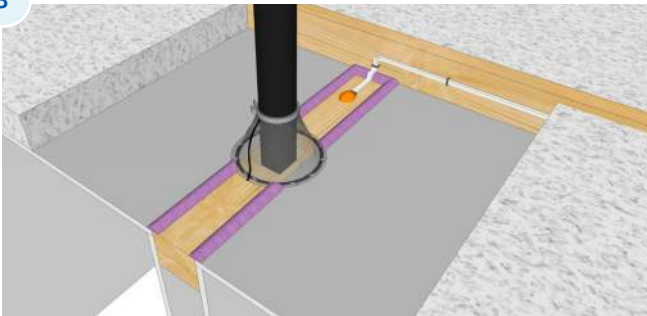

Install sealant around smaller penetrations such as electrical wires.

Install spray foam over the top plate joints and other penetrations where needed to seal the ceiling to the top plate.

4

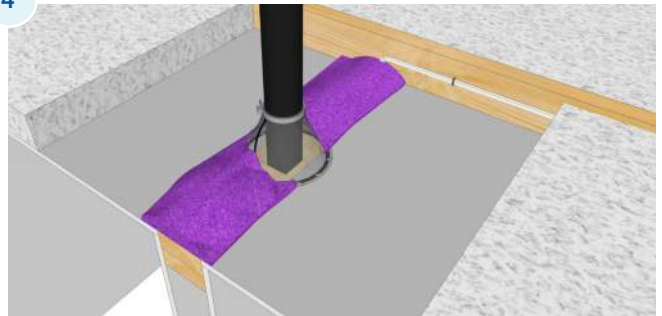

Alternatively, cover the entire top plate with spray foam at the ceiling level to minimize air leaking at gaps, small penetrations and joints.

5

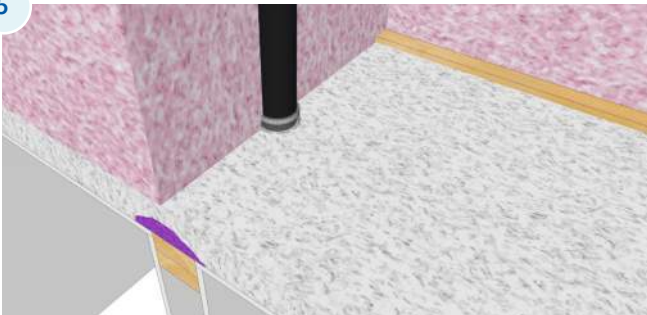

Replace existing insulation and install additional insulation.

6

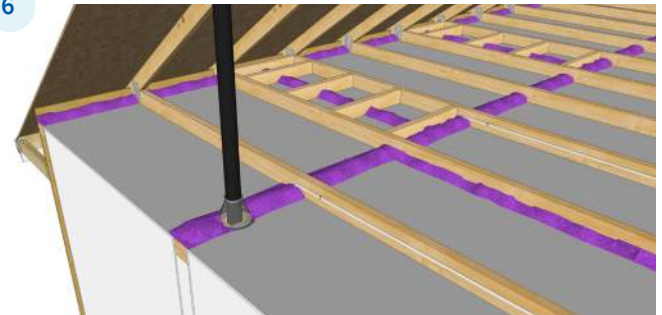

For homes with many interior walls and top plates at the ceiling, it may be prudent to completely remove the existing insulation in order to more easily view and access the top plates for repair.

7 | Large Openings, Shafts, or Drop Ceilings

Large openings in the ceiling plane, such as for service shafts or drop ceilings, can be a major cause of air leakage in attics.

This air sealing procedure is for openings in the ceiling plane running perpendicular to the ceiling joists. Where the opening runs parallel, a similar procedure can be used with some adjustments.

Items to Avoid

- Do not use thin or flimsy material such as cardboard or plastic for the cover. The material must be able to support additional insulation and remain airtight.

Items to Incorporate

- Be careful around the openings of shafts and drop ceilings. Only use the joists and rafters to move around on. Do not step on the ceiling.
- Thoroughly seal around the opening cover and all adjacent framing.



A relatively large hole in the ceiling plane through which two ducts are installed.



Spray foam around the edges of a cover, sealing it to surrounding joists and ceiling gypsum board.

Materials/Tools Needed

- Spray foam (spray can or two-part) and/or polyurethane sealant
- Wood, OSB or gypsum board
- Fasteners

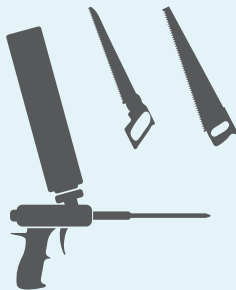

Homeowner Tips

Do not store items in the attic on top of the finished cover. Use an attic platform to keep the storage items above the level of the new insulation.

Procedure: Large Openings, Shafts, or Drop Ceilings

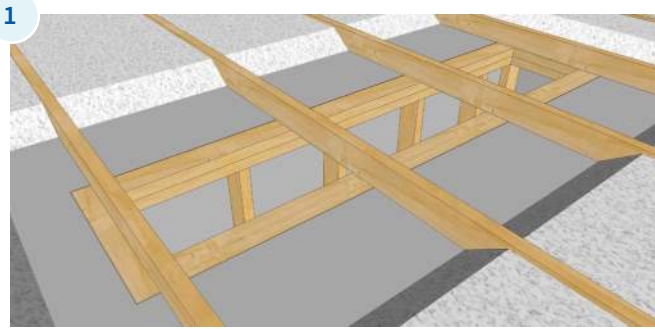

1 Expose the ceiling finish approximately 12" on all sides of the ceiling opening. Clean area to ensure adequate sealant adhesion.

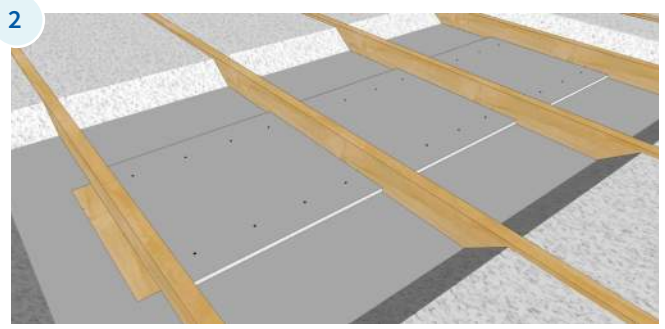

2 Install wood or gypsum board cover between joists. Screw it down to the top plate or adhere with sealant.

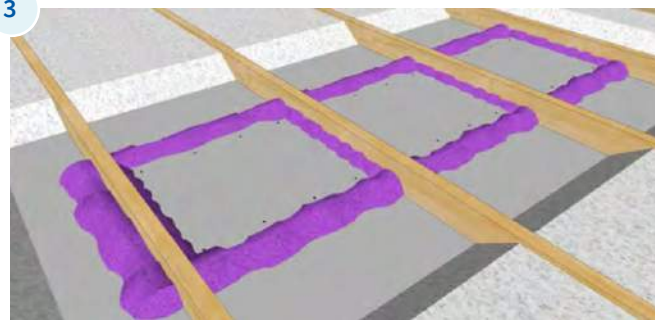

3 Install spray foam over the edges of the cover to seal it to surrounding joists and ceiling gypsum board. Seal along the ends of the drop ceiling on either side of the ceiling joist with spray foam.

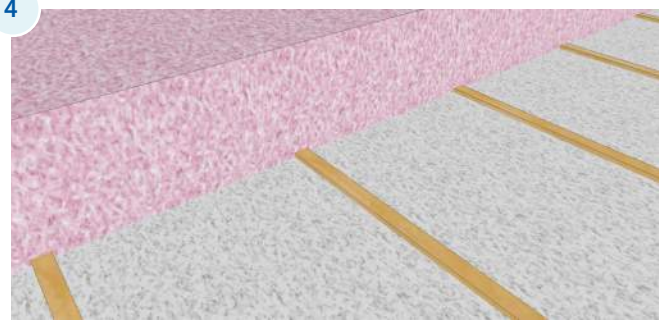

4 Replace existing insulation and, if desired, install additional insulation.

8 | Attic Knee Walls

Knee walls that divide interior space from attic space should be treated like exterior walls in how they are air sealed (and insulated). Knee walls are often built directly over upper floor framing, allowing attic/floor joists to run continuously underneath. This allows air leakage under the knee wall bottom plate in every joist space.

This air sealing and insulation procedure is for a knee wall that runs perpendicular to the floor joist framing, and an attic space with or without existing floor boards.

Items to Avoid

- Do not use rigid foam as additional insulation. Rigid mineral wool or fibreglass boards are preferred in this application (cold side of the knee wall insulation) to avoid a potential vapour diffusion issue.

Items to Incorporate

- Remove any floor boards or sub floor in the attic space, if present, to expose the joists running under the knee wall.
- Seal under the bottom plate of the knee wall along the whole length at each floor joist.



Knee wall framing.



Access hatch at knee wall.

Materials/Tools Needed

- Spray foam (spray can or two-part) and/or polyurethane sealant
- Fibre batt insulation or foam board insulation (for between joists)
- Rigid fibre insulation boards
- Gasket

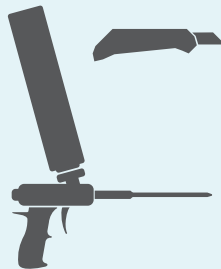

Homeowner Tips

If there is an access door to the attic space in the wall of the upper floor, make sure it is sealed with exterior door weatherstripping.

Procedure: Attic Knee Walls

1

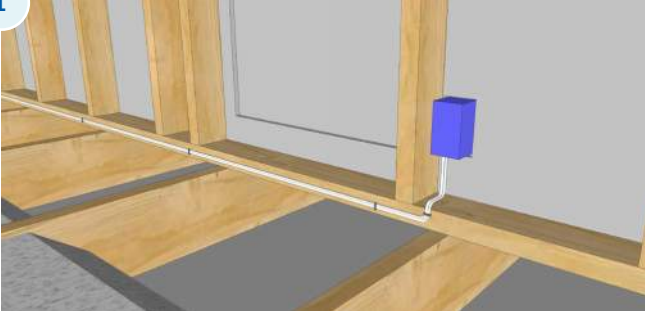

Remove insulation located underneath the knee wall and expose the ceiling finish and framing at the knee wall interface. Cut back any existing attic floorboards as necessary to expose under the bottom plate of the knee wall framing.

Remove the wall insulation to expose penetrations such as electrical receptacles and access hatches.

2

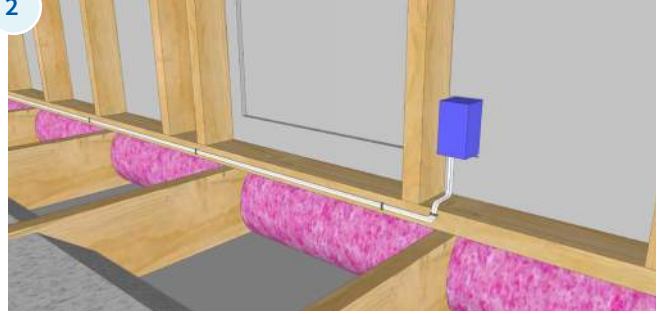

Install batt insulation or rigid foam board into the joist space under the knee wall as backer for spray foam.

3

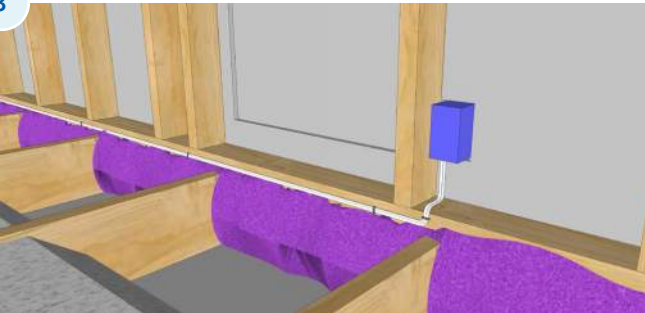

Install spray foam over the ceiling joist to knee wall interface to create an air seal. If batt insulation is used as a backer, it must be covered completely. If rigid foam board is used, it is enough to seal the perimeter of the foam board and any joints.

4



Seal all wall penetrations to the wall finish or polyethylene. Gaskets can be used to seal access hatches, and airtight foam boxes can be placed around receptacle boxes and sealed around the edges. Alternatively, this can be done from the other side of the wall according to measures described in [Air Sealing Considerations for Above-grade Walls Interior Approach](#) on page 52 .

5

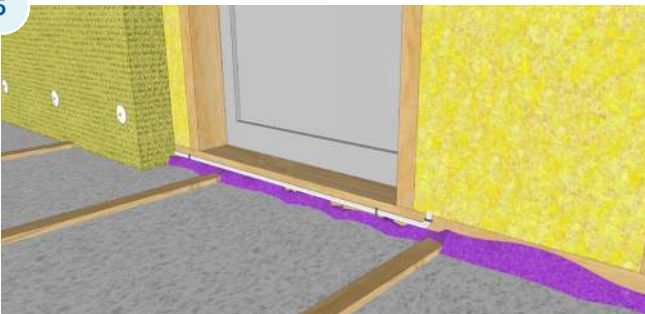

Re-install or replace the wall and attic insulation. Install additional rigid fiberglass or mineral wool insulation boards at the knee wall to increase the R-value of the wall.

6

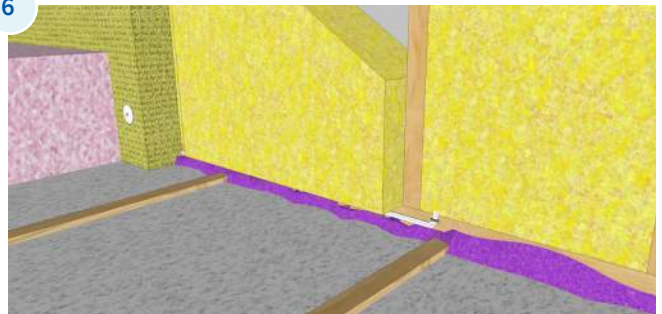

Place insulation on the inside of the access hatch. Install additional attic ceiling insulation.

9 | Ceiling Perimeter and Gable End Walls

Minimizing air leakage at the ceiling perimeter is one of the most effective air-sealing strategies to improve the home's airtightness.

If the home has a polyethylene sheet at the ceiling level that is not detailed as an air barrier, it will allow air leakage at every location where the ceiling finish terminates.

These air-sealing procedures are for the ceiling perimeter at top plates and gable end walls without a properly detailed air barrier at the ceiling plane. These procedures are not required if a polyethylene sheet is in place and runs between the two top plates of the wall, though they may still apply to service penetrations.

Note that the framing configurations shown are examples and will vary in practice.

Items to Avoid

- Do not use spray foam directly in contact with electrical fixtures or uninsulated wires.
- Do not seal between the top plates and the roof sheathing. Baffles should be re-installed or installed before the insulation to allow ventilation air to enter the attic from the soffit.

Items to Incorporate

- Use a flexible air seal such as a polyethylene sheet, rubber gasket, or flexible tape where movement is expected.
- Seal all penetrations with spray foam where no movement is expected. Ensure all surfaces are clean to achieve sealant adhesion.
- Use a fire-rated silicone sealant if sealing electrical boxes in the attic space.



Gable end wall.

Materials/Tools Needed

- Spray foam (spray can or two-part) and/or polyurethane sealant

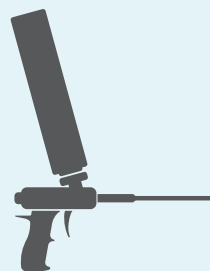

Homeowner Tips

It may be prudent to periodically enter the attic to check the condition of the roof sheathing and framing, especially around the perimeter. This is often where moisture accumulation and damage occurs from leaks or other moisture sources.

Procedure: Ceiling Perimeter at Top Plates

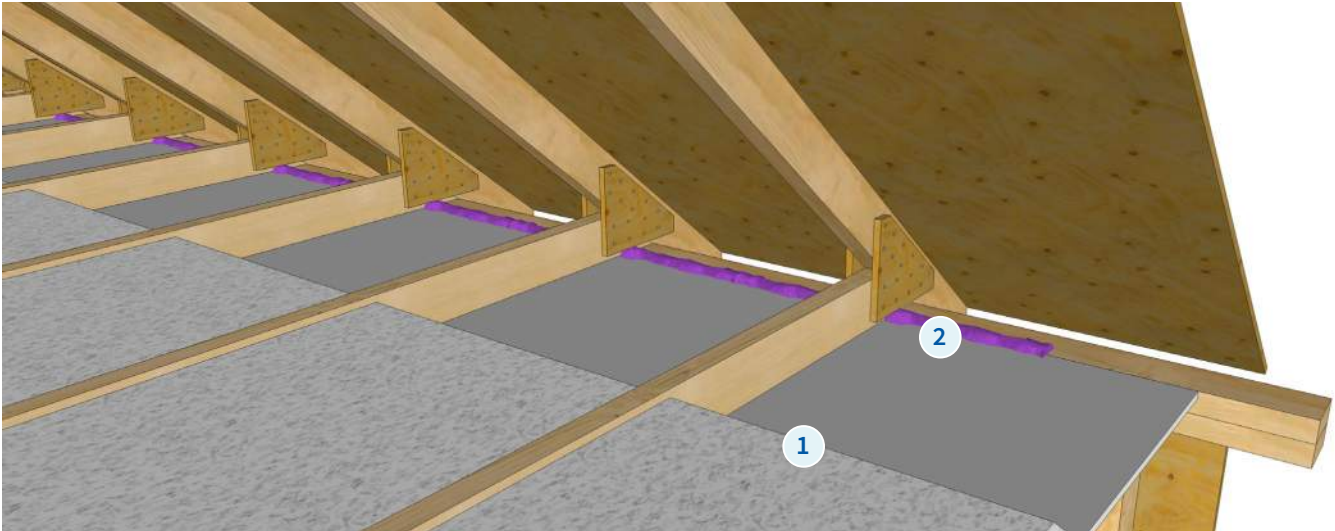

- 1 Expose the top plates to inspect the configuration of the framing.
- 2 Seal the ceiling finish to the top plate with spray foam or polyurethane sealant.
- 3 Install insulation baffles and insulation as per procedure [11 | Topping Up Existing Insulation](#) on page 44.

Procedure: Ceiling Perimeter at Gable End Wall

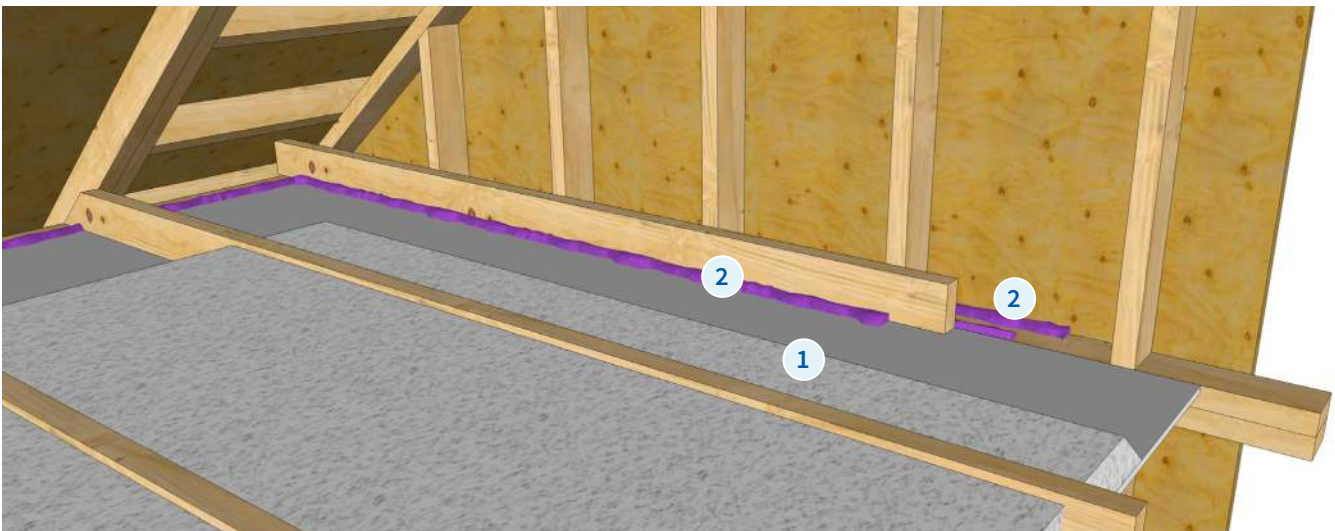

- 1 Expose the perimeter at the gable end wall to inspect the framing configuration. There are various framing configurations of gable end walls which vary from what is shown here, for example balloon framing with firestopping, rather than platform framing.
- 2 Seal the ceiling finish to appropriate framing members with spray foam or polyurethane sealant. Sealant may be required along several framing members including blocking
- 3 Install insulation similar to procedure [11 | Topping Up Existing Insulation](#) on page 44.

10 | Masonry Chimney

Fireplace masonry chimney penetrations are a major source of air leakage into attics. It is important to use only fire-proof and noncombustible sealing and insulating materials within 3” of the chimney. Fire-resistant silicone sealant is required where high temperatures are present.

The following air sealing procedures are for masonry chimneys that extend through the ceiling into the attic space. The procedure shows the installation of a fire-resistant gypsum board guard or a guard made out of noncombustible insulation board around a masonry chimney to keep combustible insulation at a safe distance from the chimney.

Items to Avoid

- Do not block off or modify the interior of the chimney. Any work on a chimney should only be done by an approved/certified HVAC contractor.

Items to Incorporate

- Ensure clearance between the chimney and all combustible building materials is 3”.
- Use fireproof sealing material when needed, such as when it is in contact with the chimney.



Masonry chimney in an attic.

Materials/Tools Needed

- Fire-resistant silicone sealant
- Sheet metal
- Gypsum board and wood framing or noncombustible rigid insulation
- Fasteners

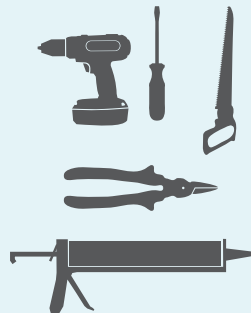

Homeowner Tips

If storage is planned in the attic, ensure that no items come in contact with the chimney.

Consider decommissioning the wood burning fireplace. The chimney can be air sealed or removed completely.

Procedure: Masonry Chimney with Gypsum Board Guard

1

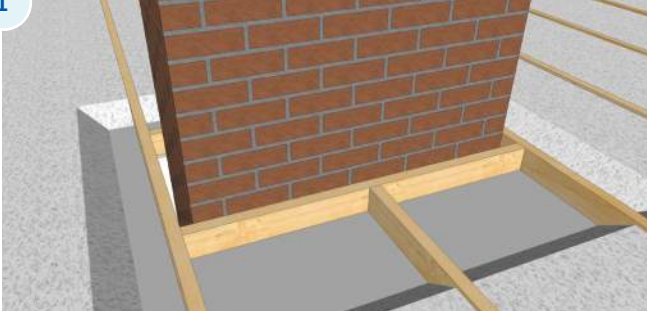

Expose the ceiling finish board approximately 12" on all sides of the chimney.

2

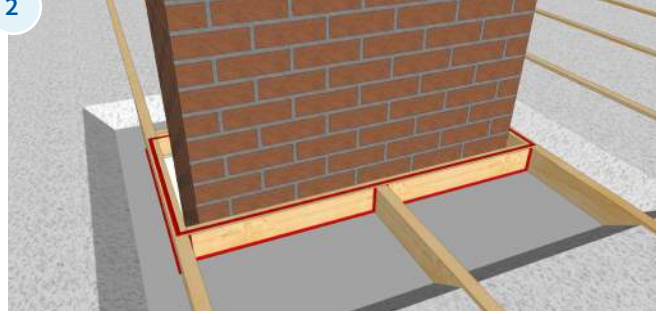

Install silicone sealant around joists and blocking to seal the ceiling finish to the framing.

Install silicone sealant along the top side of the joists and blocking in order to adhere and seal the sheet metal closure.

3

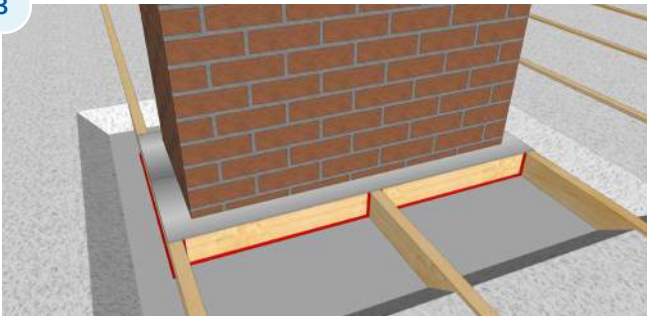

Cut and install the sheet metal closure to fit over the chimney opening tight to the masonry chimney, with overlap at each joint.

4

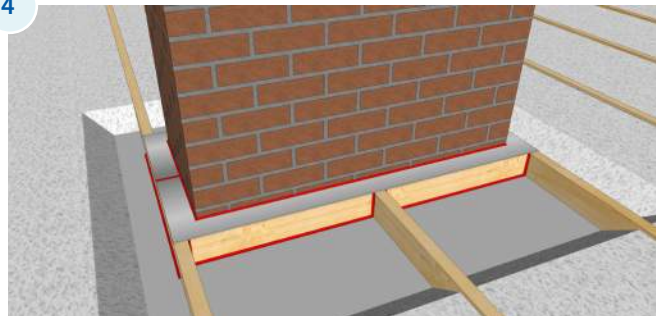

Seal the metal closure to the chimney and at each joint with silicone sealant. Sealant should be applied between the metal closures prior to installation of the second closure piece to ensure continuity of the air barrier.

5

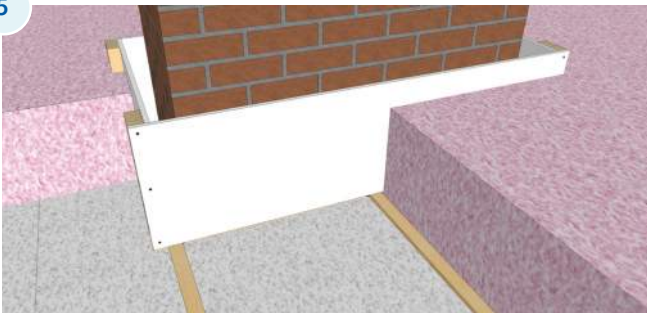

Install a framed gypsum board insulation guard around joist framing. Allow 3" space between the insulation guard and the masonry chimney. Size it so that the top edge is above the insulation, including any additional insulation that may be added. Replace existing insulation and install additional insulation around chimney insulation guard.

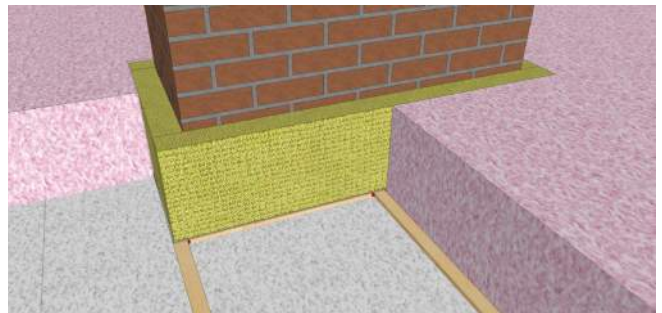

As an alternative to step 5, install 3" thick of noncombustible insulation boards around the chimney to at least the height of the additional insulation. Replace existing insulation and install additional insulation around the insulation boards.

Insulation Considerations for Accessible Attic Ceiling Spaces

Air sealing and adding insulation to the attic space is often an extremely effective energy-saving measure. The addition of insulation should only be performed in conjunction with the air sealing procedures described previously in this section. It is important to choose an appropriate insulation type and to install it properly to achieve adequate R-values. Ensure adequate attic ventilation is installed or retained during all attic insulation work.



Batt insulation.

Insulation Types

If the attic is obstructed and an irregular shape, blown-in fiberglass or cellulose may be the best option, as the loose material can fill around obstructions and provide a continuous blanket of insulation. Blown-in insulation can also be combined with batt insulation, with the loose fill above the batt insulation. Ensure that no insulation gets blown into the soffit vent area or comes in contact with heat-generating fixtures or chimneys. See the previous air sealing procedures which allow for insulation guards.

If the attic is a simple shape with joists spaced regularly at 16" or 24", fiberglass or mineral wool batt insulation may be a good alternative to blown-in insulation. Be sure to install the insulation with a snug fit but without compressing the insulation. In general, be sure to follow the manufacturers' directions when installing all types of insulation to achieve optimal results.

Both blown-in and batt insulation can be combined with spray foam in the attic space in a flash-and-fill application. See the following procedure [12 | Flash-and-Fill Insulation](#) on page 46. Additional information about insulation can be found from product manufacturers and in *Insulation: A Guide for Contractors to Share with Homeowners*, part of the U.S. Department of Energy's Building America Best Practices Series (see [Additional Resources](#) on page 84).

Insulation Thickness

Blown-in or batt fibre insulation installed on the ceiling of an attic will typically have an installed R-value of between R-3 to R-4 per inch of thickness depending on the type, manufacturer, and density. See product manufacturers' published data for specific product information. To reach the desired R-value (typically in the range of R-40 to R-60), the insulation should be installed to the desired thickness per the table below. Note that the insulation thickness will be reduced at the eaves due to the slope of the roof sheathing and this will reduce the effective R-value of the ceiling plane. This deficiency can typically be made up by adding a few extra inches of insulation in the centre, unless the roof slope is particularly shallow. Guidance on the reduction calculation can be found in the *Guide for Designing Energy Efficient Building Enclosures* published by FPIInnovations (see [Additional Resources](#) on page 84).

Insulation R-value/inch	Insulation Thickness (inches)				
	12	14	16	18	20
3.0	36	42	48	54	60
3.4	41	48	54	61	68
3.8	46	53	61	68	76
4.0	48	56	64	72	80



Blown-in attic insulation



Insulation baffles installed at every second truss bay prior to installation of insulation to provide openings past the insulation from the soffit vents to the attic space.

Attic Ventilation

Attic spaces in older homes in BC were often designed as vented spaces. If the attic is not vented and has not been insulated at the roof plane, it is possible that the original attic vents were at some point blocked off incidentally during re-roofing (e.g. cedar shingle/shake to asphalt shingle conversion) or other home renovations. Attic ventilation is an important factor in controlling moisture in the attic, reducing heat build-up in summer, and reducing ice damming in snowy climates. Poor attic ventilation, coupled with the leakage of indoor air into the attic, causes most attic moisture and mould problems in B.C.

For attic ventilation to be most effective, outdoor air should enter the attic low at the attic perimeter (i.e. at the soffits) and exit high near the attic ridge (i.e. ridge vents or cap vents installed near the ridge). The soffit vents can be provided in the form of perforated soffit material, discrete vents in the soffit material, or — if no soffit is present — button vents near the edge of the attic. If there is a gable end wall, vents may also be placed near the bottom of these walls above the insulation level. Powered or wind-driven attic vents such as "whirly birds" should not be used as a means of attic ventilation as they can lead to depressurization of the attic space and cause additional air leakage. Soffit vents must connect through to the attic and past the insulation, typically by the use of insulation baffles or guards. Typically, these are placed between trusses at every bay or every second bay, depending on the roof configuration and available soffit area for venting.

The area and size of attic vents can be determined by referencing the BC Building Code, which requires attics to be vented with a net free vent area of 1:300 (2012 BCBC).

This means that for every 300 square feet of ceiling area, one square foot of vent is required. The code allows for up to 75 percent of the vent area to be distributed at either the top or the bottom. However, it is generally accepted better practice to evenly distribute the vents between the soffit area and ridge. If it is not possible to balance the venting arrangement, then it is best to install more of the vents at the soffit rather than the ridge, to reduce the risk of depressurization in the attic as a result of wind. While the 1:300 rule is a minimum code requirement, it should also not be exceeded by a large margin. Providing too much ventilation can cause moisture problems in coastal climates.

After air sealing measures have been performed, the amount of air leakage into the attic should be substantially reduced. In addition, the vapour barrier at the ceiling plane (painted ceiling finish, kraft-faced batts, or polyethylene sheet) will limit the amount of vapour diffusion into the space.

Attic ventilation may still be beneficial even if the original attic was not ventilated. Vents could be added as part of the insulation retrofit. When attic vents are installed through the roofing material, a roofing contractor should be hired to properly install, shingle, and seal the vent in the existing roofing. It is common to see an attic vent cause a roof leak due to a poor installation. Holes are best cut through roofing at the time of re-roofing, but this does not always coincide with weatherization work.

11 | Topping Up Existing Insulation

The most common and simplest way to add thermal resistance to an attic is to add attic insulation. The new insulation may be added on top of any existing insulation. However, existing insulation may need to be temporarily moved to allow access to seal at air leakage points before the new insulation is installed.

Insulation baffles should be installed as required to allow for proper attic ventilation. Insulation retention should be provided where blown-in insulation is to be installed, to keep the blown-in insulation from falling out of the attic and into the soffit space.

Items to Avoid

- Do not let insulation contact non-IC-rated light fixtures, combustion exhaust venting, or chimneys. Refer to the air sealing procedures provided in the previous pages of this section for details.

Items to Incorporate

- Ensure all roof/attic ventilation openings are clear of insulation and debris.
- Install the insulation to achieve a continuous, non-compressed blanket of insulation.



Blown-in insulation in packaging



Consumer-grade insulation blowing machine

Materials/Tools Needed

- Spray foam (spray can or two-part) and/or polyurethane sealant
- Batt insulation
- Blown-in or batt attic insulation
- Pre-formed insulation baffles

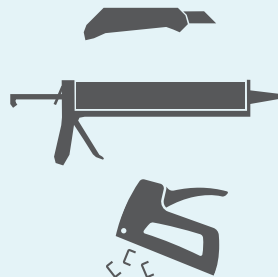

Homeowner Tips

The attic floor should not be used for storage unless a platform is constructed above the insulation. Any compressed insulation should be re-fluffed to the original depth if the attic floor is walked on.

Procedure: Topping Up Existing Insulation

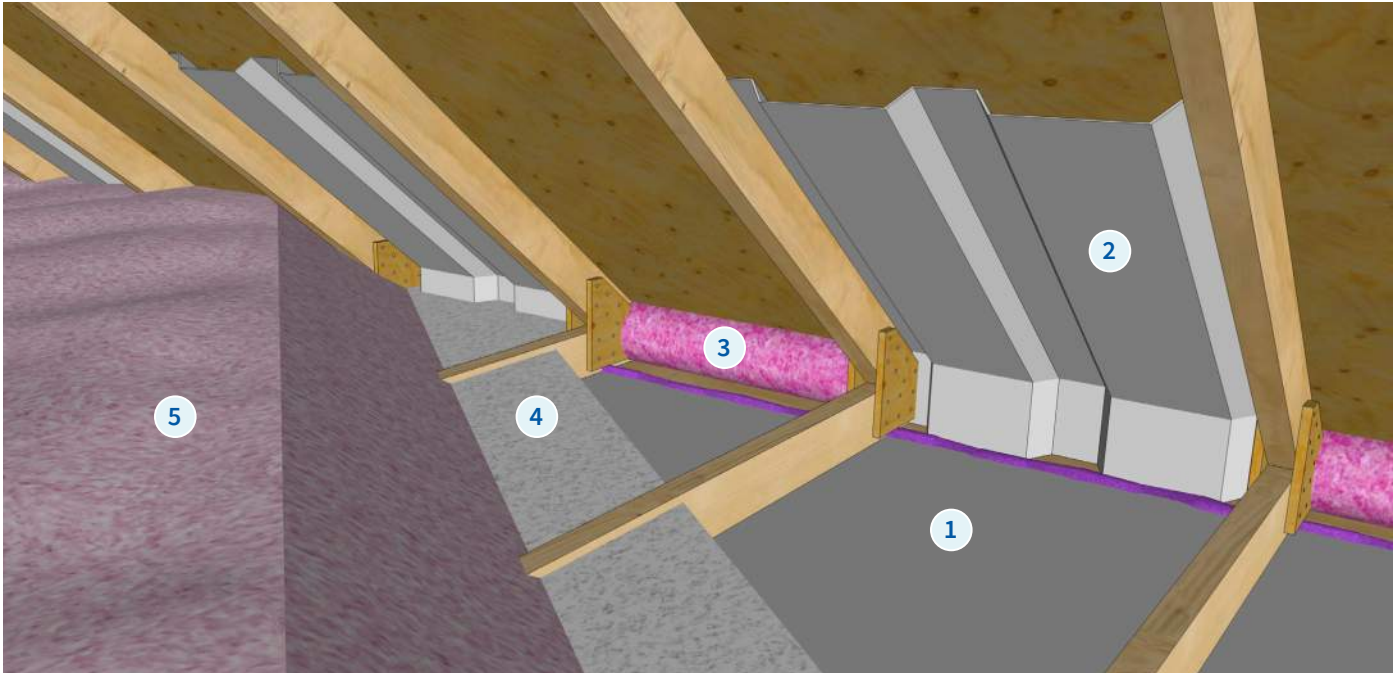

- 1 Remove existing insulation and air seal the attic as shown in [9 | Ceiling Perimeter and Gable End Walls](#) on page 38.
- 2 Install insulation baffles as required along the roof edge, or above each soffit ventilation port if it is not a continuous soffit vent.
- 3 Install batt insulation into every empty joist space to block new blown-in attic insulation from entering the soffit space.
- 4 Re-install existing attic insulation (if present).
- 5 Install additional attic insulation per the manufacturer's instructions. See previous page for guidance on the appropriate insulation type, and appendices for guidance on the amount of insulation needed.

12 | Flash-and-Fill Insulation

The flash-and-fill application in the attic simplifies the air sealing process where there may be many air leakage paths. The continuous spray foam creates a single airtight layer at the ceiling before additional insulation is installed. It is important to review the previous air sealing procedures if there are non-IC-rated pot-lights, service penetrations subject to movement, and chimneys in the attic. Flash-and-fill is especially efficient if the ceiling is a material with many gaps, such as wood panelling or tongue and groove boards. In addition to air sealing the attic, closed-cell spray foam can provide a continuous vapour barrier at the ceiling plane, further reducing moisture entering the attic from the living space.

This procedure is for the flash-and-fill application in an accessible attic.

Items to Avoid

- Do not apply a layer of closed-cell spray foam greater than 2” thick or into a concealed void.

Items to Incorporate

- Ensure the contractor is trained in this application.
- Ensure all correct air sealing, separation, and protection measures have been taken around heat-generating fixtures and other service penetrations prior to flash coat.
- Follow all manufacturer's instructions when using spray foam.



Flash-and-fill attic installation where a few inches of spray foam is sprayed to the top of the ceiling finish, and then covered with lower cost low-density cellulose or fibreglass insulation fill.

Materials/Tools Needed

- Batt insulation
- Spray polyurethane foam (large amounts required; use of a spray foam insulation contractor is recommended)
- Blown-in or batt attic insulation
- Pre-formed insulation baffles

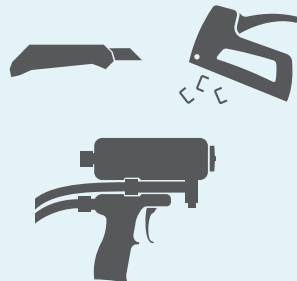

Homeowner Tips

Consider replacing existing pot lights to IC/AT-rated LED pot lights to maximize the thermal effectiveness of the attic insulation.

Procedure: Flash-and-Fill Insulation

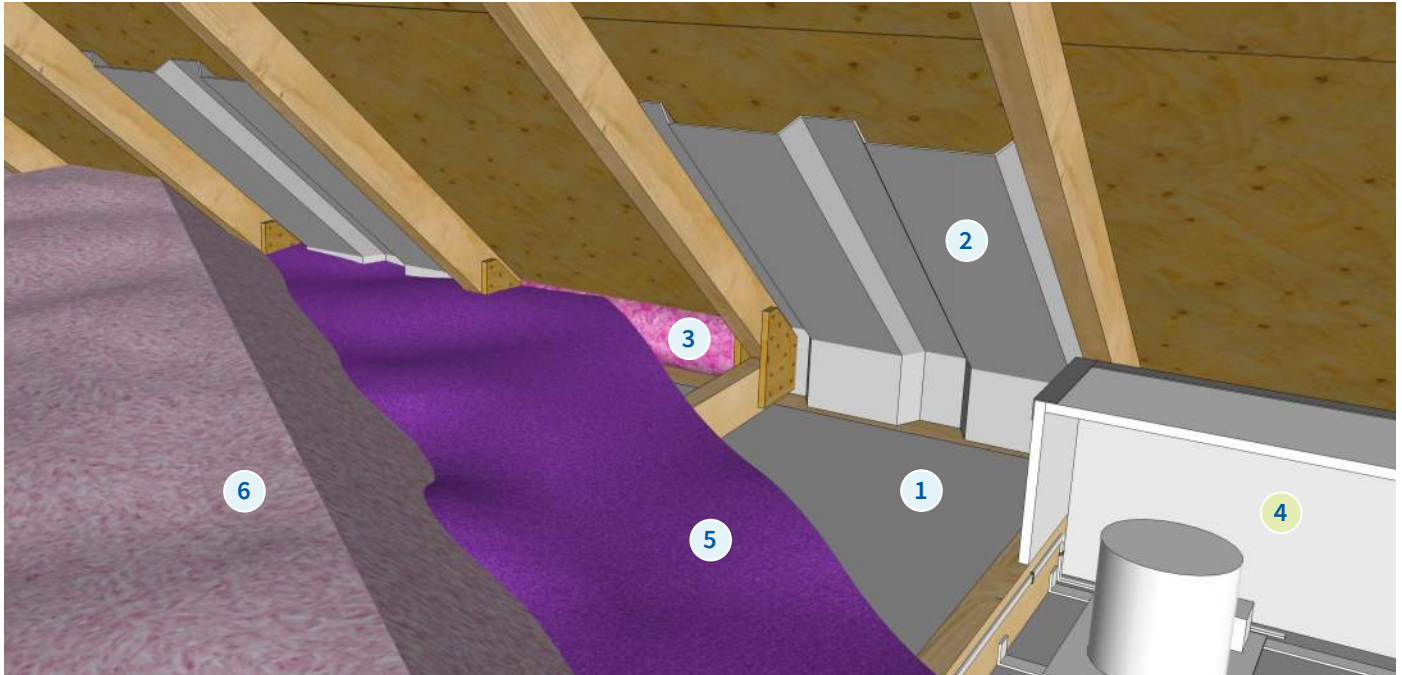

- 1 Remove all the existing attic insulation and thoroughly clean the attic floor.
- 2 Install insulation baffles as required along the roof edge, or above each attic ventilation port if it is not a continuous soffit vent.
- 3 Install batt insulation into every empty joist space to block new blown-in attic insulation from entering the soffit space.
- 4 Follow the previously described attic air sealing procedures as necessary to protect non-IC/AT-rated pot lights and other electrical fixtures, combustion exhaust flue vents, and large holes prior to flash coat. Failure to do so can result in spray foam in undesirable locations or damage to existing components.
- 5 Flash coat the entire attic floor with a coat of spray foam to create a continuous air seal.
- 6 Install new attic ceiling insulation.

Air Sealing Considerations for Inaccessible Attics and Vaulted/Flat Ceilings

Air sealing a vaulted ceiling below ceiling joists with no attic space is most feasible from the interior side. If no major ceiling removal work is planned, it is best to seal all penetrations in the ceiling finish with appropriate sealants. A gypsum board ceiling is a good air barrier material, so sealing the penetrations is important to make most of the ceiling airtight.

The air-sealing locations discussed here are for vaulted ceilings, ceilings below flat roofs, or ceilings that do not have an accessible attic space above them.



Vaulted gypsum board ceiling with face-mounted and recessed pot light fixtures.

Typical Air Sealing Locations and Procedures at Inaccessible Attics and Vaulted/Flat Ceilings:

- 1 Seal tops of partition and exterior walls at the ceiling with paintable polyurethane sealant.
- 2 Seal support structures like beams and columns to the surrounding components with paintable polyurethane sealant.
- 3 Seal skylight frames with polyurethane sealant.
- 4 Seal electrical receptacles, light fixtures, and other ceiling fixtures behind the trim plates with spray foam, gaskets, or acoustical sealant (to prevent permanent adhesion).
- 5 Seal exhaust vents and chimney openings with fire-resistant silicone sealant. Fire-resistant silicone sealant needs to be used at all hot and combustion air exhaust vents and chimney penetrations.

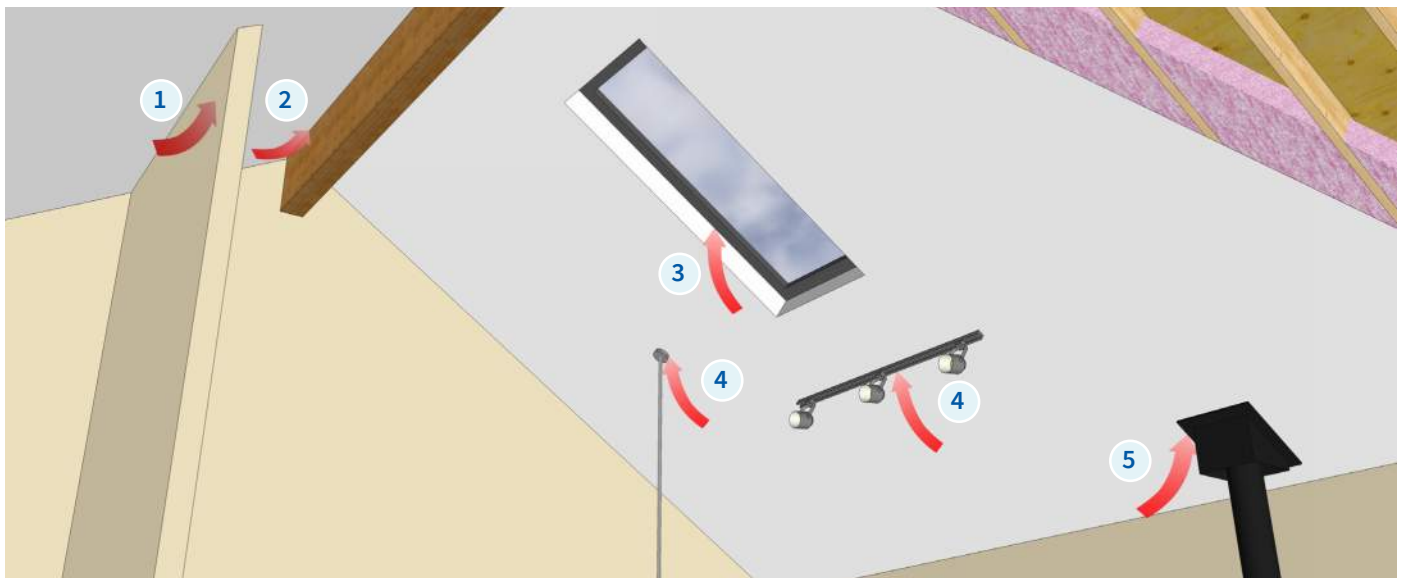

Insulation Considerations for Inaccessible Attics and Vaulted/Flat Ceilings

The building enclosure can be retrofitted from either the exterior or the interior. The most appropriate method for a given application depends on the house's interior and exterior finishes, layout and construction, setback and height restrictions, other renovation needs, and whether the house will be occupied during the work. For example, if the roofing is being replaced as part of previously planned renovations, an air sealing and insulation program applied from the exterior is likely most appropriate, whereas interior renovations may more easily facilitate interior retrofit work.

Two conceptual roof insulation retrofits for existing wood-frame homes are covered here using either an interior or exterior insulation approach. Many industry references provide additional information and details for this type of more extensive work.

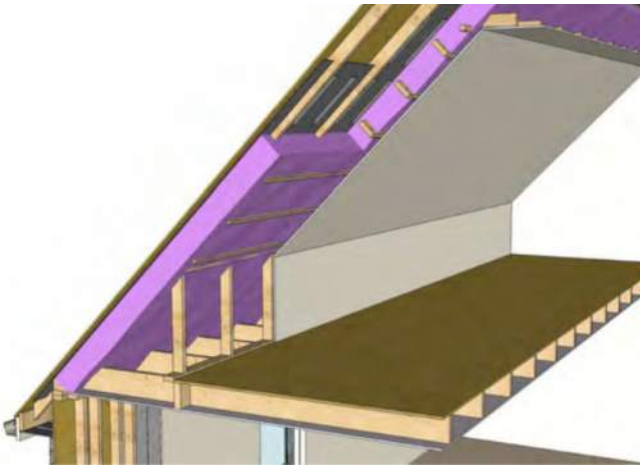

Insulation is added to the interior of the existing insulation in an interior retrofit.



Insulation is added to the exterior of the existing insulation in an exterior retrofit.

Interior Retrofit

An important advantage of interior retrofits is they can typically be carried out year-round, because the exterior components are not impacted by the work. This type of retrofit may also be necessary if property-line setbacks do not allow for increasing the thickness of the enclosure on the exterior. For vaulted ceilings or inaccessible attics, insulating from the interior is best suited for spaces where interior remodelling is already taking place and headroom is not limited.

Since existing roof joists are not usually deeper than eight to ten inches, adding rigid insulation to the underside of the joists to increase the R-value of the roof should be considered. Adding insulation below the joists will lower the level of the existing ceiling finish and potentially impact headroom. Insulating from the interior also presents the opportunity to inspect the existing elements of the roof for decay or damage. As with all assemblies where insulation is added on the interior, particular attention must be paid to the air barrier and vapour retarder, because increased insulation levels can decrease sheathing and framing temperatures and consequently increase the risk of condensation and associated moisture damage.

Exterior Retrofit

An exterior retrofit can be most appropriate when interior floor area is limited, when exterior renovation work is planned, and to limit disturbance to house occupants. This method also provides an opportunity to detect and repair water entry problems. Air sealing and installation of insulation on the exterior of a house also has a number of technical advantages. It is often easier to avoid large thermal bridges, such as studs and joists in exterior insulation, making the insulation more effective. Air sealing from the exterior is often simpler because there are fewer penetrations to accommodate. Additionally, exterior insulation increases the temperature of sheathing and framing, which reduces the potential for condensation and associated damage. Insulating the roof/attic from the exterior is most applicable when the existing roof is too shallow to accommodate target insulation levels or when other work on the roof is planned.

13 | Interior Retrofit

Insulating a vaulted ceiling from the interior requires removal of the interior finish. The joist space must be accessed to ensure adequate ventilation against the underside of the existing sheathing. Blown-in cellulose or fiberglass insulation should not be installed blind from the inside into vaulted ceilings or flat roofs. Ventilation is required to inhibit condensation and allow the wood structure to dry, and is particularly important in a retrofit application. Since the ceiling finish must be removed anyway, it is advisable to add interior insulation to increase the R-value of the roof assembly. However, this is not required. Additional insulation can be installed on the underside of the existing roof joists, or extra framing can be added to increase the roof joist depth.

Moisture Control for Dense-Packed Roof Assemblies in Cold Climates: Final Measure Guideline by Building Science Corporation is a good source of further guidance regarding interior insulation of vaulted ceilings (see [Additional Resources](#) on page 84).

Conceptual Insulating Procedure: Interior Retrofit

- 1 Remove the interior finish and insulation (if any) and expose the existing roof sheathing. Inspect and repair framing and sheathing as needed.
- 2 Use insulation baffles such as 1/4" plywood or perforated baffles to create a vent on the underside of the sheathing.
- 3 Install batt insulation to the depth of the roof joist against the baffles.
- 4 Install rigid foam insulation against the underside of the roof joists. Tape joints to ensure airtightness. Fasten insulation to the underside of the roof joists with wood strapping.

Option: Use gypsum board with gaskets to create airtight drywall. If no rigid foam is installed or if rigid mineral wool is used in place of rigid foam, an air barrier/ vapour retarder such as polyethylene or vapour retarder paint on drywall must be installed at the interior side of the insulation. Alternatively, use closed-cell spray foam as the air barrier and vapour retarder.

- 5 Install interior finish.

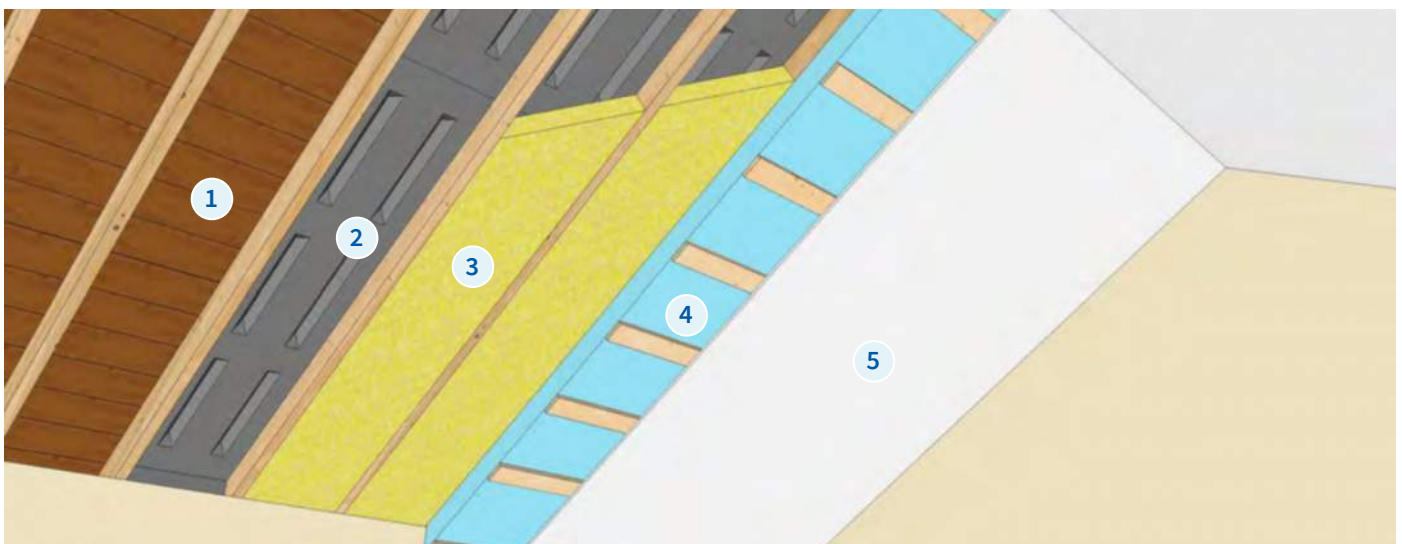

14 | Exterior Retrofit

Insulating a sloped roof from the exterior requires gaining access to the existing roof sheathing and re-roofing. Where exterior roofing work is already required, or if there is no interior access, insulation should be added to the exterior of the roof. The amount of insulation to add depends on local requirements (maximum height restrictions) and cost effectiveness. Note that the addition of exterior insulation to a roof that is already insulated on the interior is acceptable. Ventilation is recommended between the new insulation and the new sheathing to allow moisture to dry out and reduce ice-damming issues in snowy regions. Adding exterior insulation often requires overhangs to be re-constructed and may change the appearance of the house.

Building Science Corporation has numerous references and suggestions for details on exterior roof retrofits (buildingscience.com)

Conceptual Insulating Procedure: Exterior Retrofit

- 1 Remove the existing roofing and underlay. Inspect and repair framing and sheathing as needed.
- 2 Install a new self-adhered airtight membrane over the existing sheathing. Use vapour impermeable air barrier if no vapour retarder is present in the existing roof assembly.
- 3 Attach rigid mineral wool or foam insulation over the air barrier with strapping to allow for cross ventilation over the insulation.
- 4 Install new sheathing over the strapping.
- 5 Install new underlay and roofing.

Note: A ventilation path must be present for the cross strapping to allow ventilation over the insulation and at the underside of the new roof sheathing.

Note: Continuity in the air barrier must be present between the underside of the roof and the top of the exterior wall. Spray foam or other sealing methods should be used. See [Additional Resources](#) on page 84 for published details and additional sources.

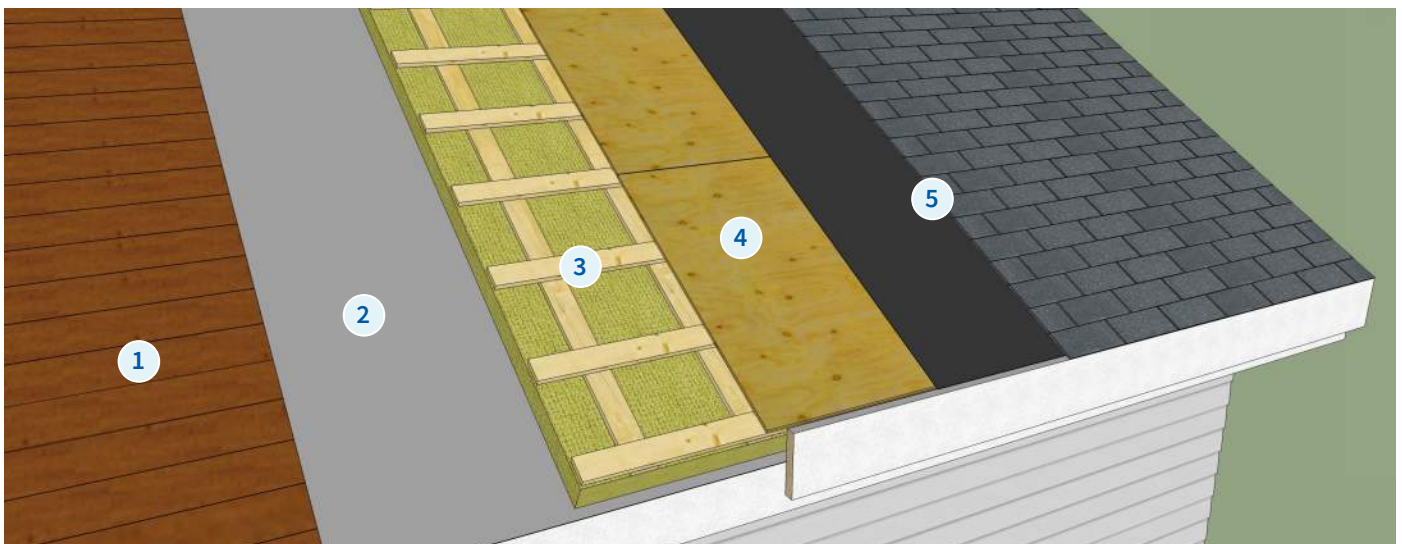

Air Sealing Considerations for Above-Grade Walls Interior Approach

Air sealing the walls of a house consists mainly of sealing all large openings and service penetrations. Exterior doors and windows can be significant sources of air leakage, and small electrical fixtures and service penetrations can also contribute to air leakage. Most air sealing can be accomplished with gaskets, sealants, and spray foam, but if larger holes are to be sealed, more robust air sealing procedures may be needed.

Note: Use fire-resistant silicone sealant around hot exhaust vents and chimneys.

Note: Other interfaces like rim joists and wall intersections are not included due to the extensive work required. If major interior work is planned, see [Considerations for Interior and Exterior Retrofits](#) on page 58 and [Typical Air Sealing Locations at Below-grade Walls](#) on page 68.

Typical Interior Air Sealing Locations and Procedures at Above-grade Exterior Walls:

- 1 Seal electrical receptacles, light fixtures, and other small wall fixtures behind the trim plates with acoustical sealant or foam gaskets (to prevent permanent adhesion).
- 2 Seal and adjust exterior doors using adhered weather stripping and gaskets.
- 3 Seal window frames with polyurethane sealant. Adjust and seal operable windows using adhered weather stripping and gaskets (see [Windows and Doors](#) on page 80 for more information).

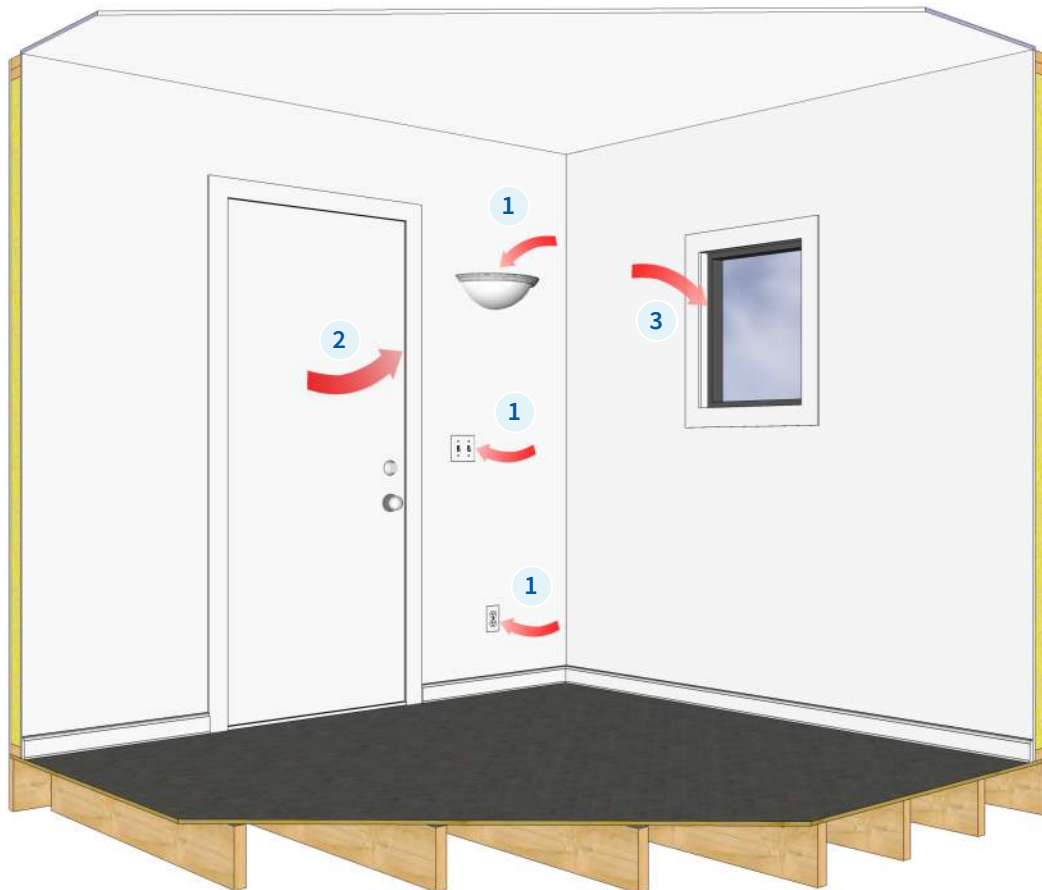

Air Sealing Considerations for Exterior Washroom Walls

Air leakage through exterior walls of washrooms can lead to significant damage to the stud cavity due to the increased humidity in these rooms. All air leakage locations should be sealed off to prevent humid air from flowing into the wall framing and condensing in the stud cavities.

Sealing penetrations, corners, and trim is inexpensive and easy to do from inside the washroom. In conjunction with renovations, bathtubs and showers should be installed airtight against the walls and the floor.

Typical Interior Air Sealing Locations and Procedures at Above-grade Exterior Washroom Walls:

- 1 Seal mechanical, electrical, plumbing, and other services penetrating exterior walls with polyurethane spray foam or sealant.
- 2 During bathroom renovations bathtubs and shower stalls should be installed airtight against the walls and the floor.
- 3 During bathroom renovations the wall backerboard should be installed airtight.

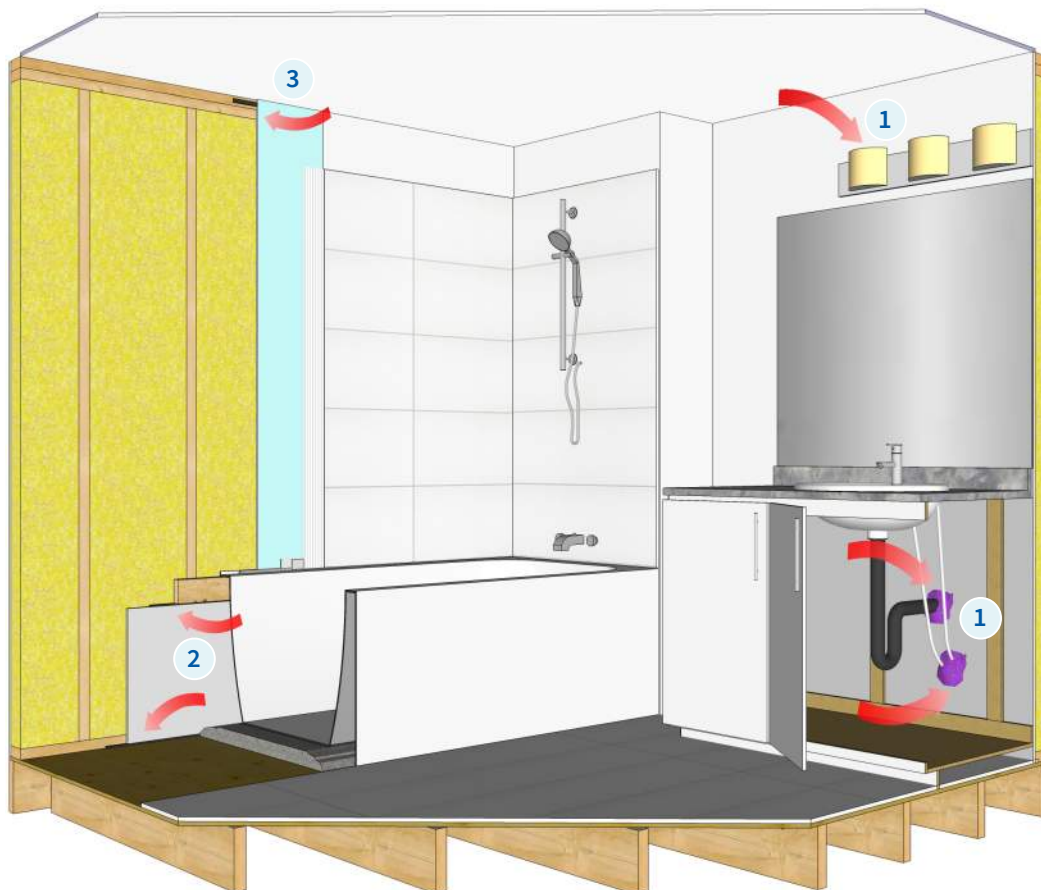

15 | Exhaust Vents Through Walls and Soffits

Exhaust ducts carry humid air from bathroom fans, kitchen fans, and dryers to the outside, and need to function properly to ensure healthy indoor air quality. It is important to seal ducts penetrating through walls in rooms with elevated humidity levels, such as bathrooms, as the amount of water that could condense inside the exterior wall through air leakage is high.

Exhaust ducts should be installed to drain condensation build-up to the outdoors, and filters should be accessible so the occupants can perform regular cleaning to avoid blockage.

This air sealing procedure is for metal exhaust vents that extend through above-grade walls.

Items to Avoid

- Bends and other configurations that will catch debris and end up as blockage.

Items to Incorporate

- Install lint traps, filters, and exhaust vents so they are easily accessible for cleaning and maintenance.
- Slope the duct outward where possible so that any condensation within the duct can drain to the outside of the envelope.



Unsealed duct penetrating the exterior wall. Duct penetrations should be airtight to avoid moist air being drawn through the wall and condensing inside the wall.

Materials/Tools Needed

- Spray foam (spray can or two-part) and/or polyurethane sealant
- New ducts and foil tape (if required)

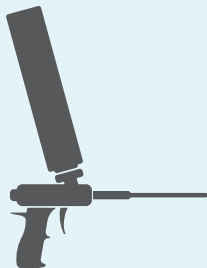

Homeowner Tips

Keep the exhaust fan clean to ensure adequate ventilation. Use a vacuum or duster to regularly clean the fan and inside the housing.

Consider replacing an old and noisy bathroom fan with a new quieter and more energy efficient model at the time of this work. Look for a fan that is Energy Star® qualified with a noise level of less than 1.0 sone.

Procedure: Exhaust Vent Through Wall

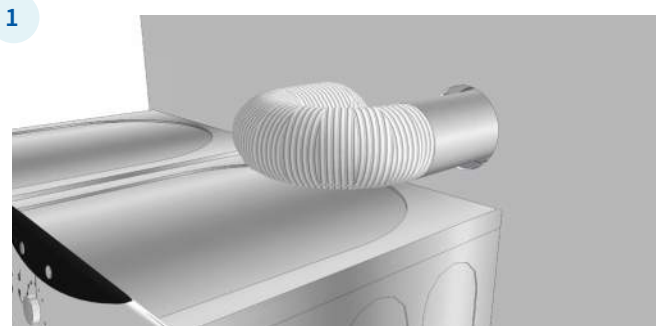

1 Ensure the duct going through the wall is airtight. If not, seal it or replace it.

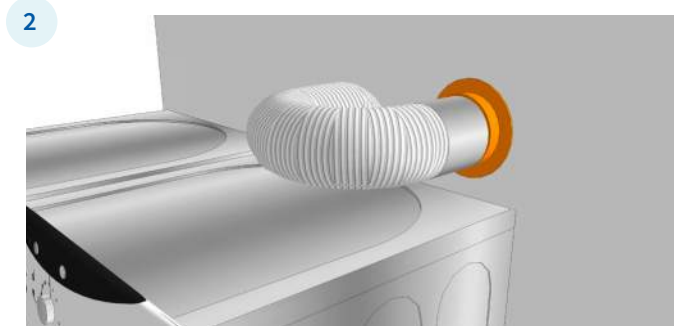

2 Install joint sealant around the duct penetration.

Procedure: Exhaust Vent Through Rim Joist

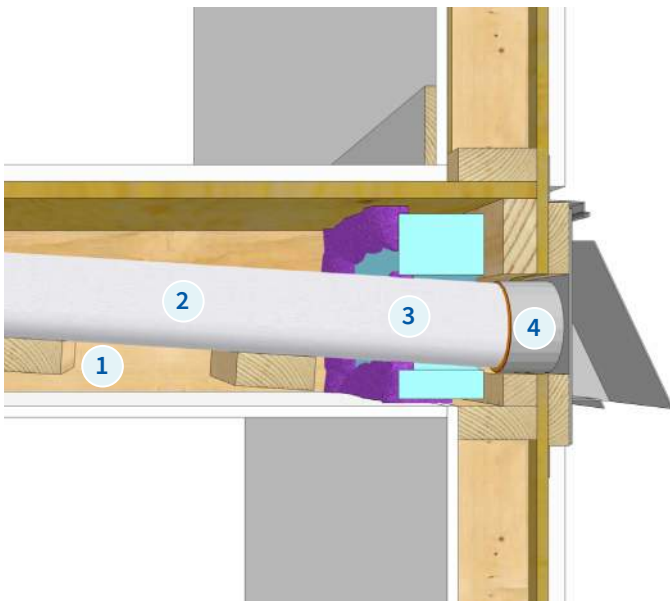

- 1 Slope the duct towards the exhaust. Install duct supports as required to prevent the duct from sagging.
- 2 All duct joints should be sealed with foil tape.
- 3 Seal around the duct wall penetration.
- 4 Place sealant between the duct and vent hood.

16 | Stud Bay Blown-in Insulation Retrofit

Insulating the wall stud space with blown-in insulation can be an economical way to increase the thermal performance of the exterior above-grade walls without major intrusion. The work should only be done if there is no existing wall insulation. In addition, the interior side must be made airtight, and should be painted with a vapour-retarding paint in order to avoid condensation on the exterior sheathing. This procedure can be completed from the interior or the exterior, depending on the exterior siding and whether interior disruption is possible. It is important to ensure the stud bays are completely filled by using multiple ports in each stud space. This also includes stud spaces above and below windows and doors.

These conceptual insulating procedures are for exterior walls where increased wall R-value is desired, but major insulation retrofit work is not possible. It is recommended that this work be completed by an insulation contractor specializing in this type of approach.

Items to Avoid

- Do not leave holes open or unsealed. Care must be taken to adequately repair each interior hole to ensure airtightness and each exterior hole to avoid water intrusion.

Items to Incorporate

- Ensure the insulation has uniformly filled each stud space. Centre the holes in each cavity as much as possible using a stud finder.
- Ensure the wall is airtight and will not pose a risk of condensation at the exterior sheathing.
- Ensure holes are not drilled where electrical wires or other services are located.



Older homes may have little or no existing insulation in the stud cavities.

Materials/Tools Needed

- Blown-in cellulose or fibreglass insulation
- Drywall/plaster repair materials (if needed)
- Vapour-retarding interior paint

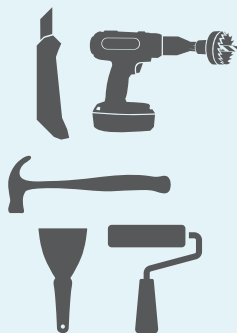

Homeowner Tips

Consider removing the exterior siding and/or installing exterior insulation. Alternatively, consider an interior insulation retrofit. See [Considerations for Interior and Exterior Retrofits](#) on page 58.

Conceptual Insulating Procedure: Installing Blown-in Insulation from the Interior



- 1 Drill a hole in the interior finish in the centre of the stud space at the top and bottom of the wall. Install blown-in insulation in each stud space as needed.
- 2 Fill the lower portion of the stud bay until the nozzle stops blowing insulation. Move the nozzle to the upper hole and fill the rest of the space.
- 3 Install an interior patch and finish as needed.

Conceptual Insulating Procedure: Installing Blown-in Insulation from the Exterior

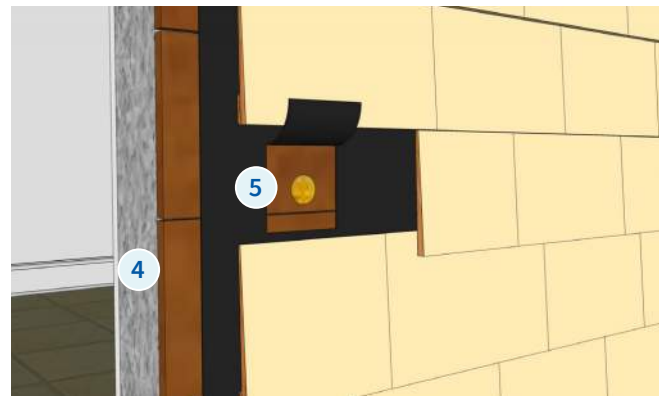
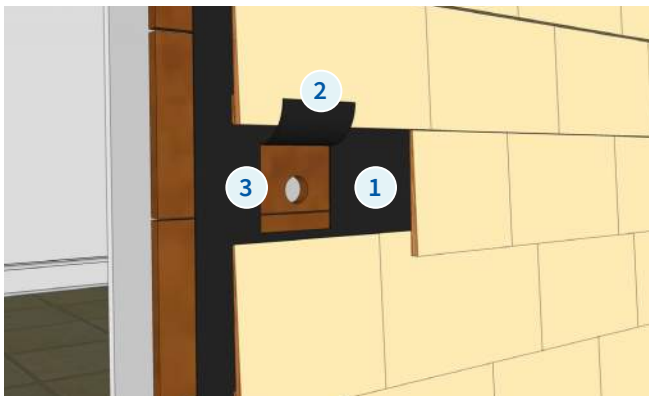

- 1 Locate each stud space and remove the siding in the centre of the stud space at the top and bottom of the wall.
- 2 Cut a flap into the sheathing membrane and expose the sheathing.
- 3 Drill a hole into the exposed sheathing sized for the insulation nozzle. Ensure the hole is roughly centered in the stud space.
- 4 Fill the lower portion of the stud bay until the nozzle stops blowing insulation. Move the nozzle to the upper hole and fill the rest of the space.
- 5 Insert a plug in the sheathing holes and fold down the sheathing membrane. Tape the sides and bottom edge of the membrane flap.
- 6 Re-install the siding and repair as needed. Shingles and wood siding can be re-installed with nails and painted. Vinyl and metal siding can be re-installed and repaired as needed.

Considerations for Interior and Exterior Retrofits

Insulating exterior walls as part of energy-efficiency measures for the whole house can significantly reduce energy consumption and save heating and cooling costs. Three strategies are presented in this guide, including the top-up strategy previously discussed, and two major retrofit methods where insulation is added to the interior or the exterior of the existing insulation. While major insulation retrofits are more intrusive they are generally more cost effective when combined with interior or exterior work already taking place. The potential energy savings can also be a compelling reason to initiate work.

See [Windows and Doors](#) on page 80, and the industry guide *Best Practices for Window and Door Replacement in Wood-Frame Buildings* published by the Fenestration Association of BC and BC Housing (see [Additional Resources](#) on page 84) for more information on how to integrate windows and doors into an insulation retrofit project.

Interior Retrofit

As with all major insulation retrofit work, insulating the walls from the interior side is best suited when interior remodelling is taking place, and when some loss of floor space is acceptable. Older homes do not generally have sufficiently thick walls to accommodate added insulation in the stud space. In order to make the energy savings retrofit worthwhile, additional wall framing is likely necessary on the interior side of the existing framing, to provide a larger wall cavity to accommodate more insulation and a higher R-value. The advantage of insulating from the interior is that no exterior work is needed. The main disadvantages are the increased risk of condensation and reduced drying ability due to colder exterior sheathing temperatures and a loss of living space. Special care must be taken on the interior plane of airtightness to avoid air leakage and vapour-diffusion condensation.

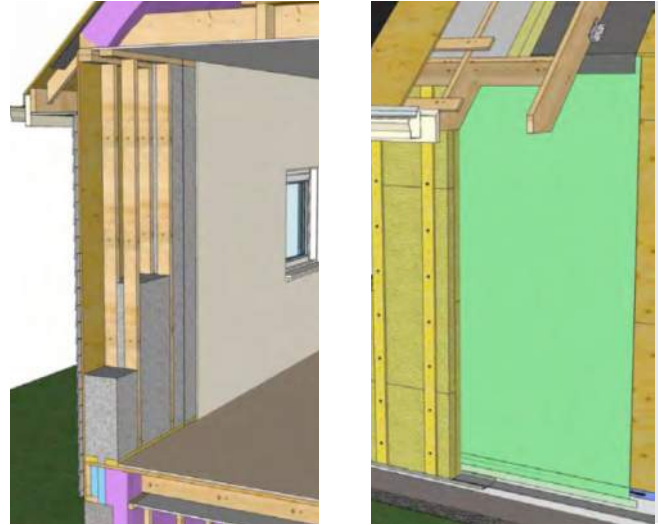

The interior insulating strategy (left), and the exterior insulation strategy (right).

Exterior Retrofit

Exterior insulating makes the most sense when exterior work is already taking place and the existing cladding and wall membrane is removed. Ensure property setback distances will not be encroached when considering the exterior insulation thickness to achieve the desired R-value. Insulating from the exterior is also the best way to ensure a proper air barrier is installed on the exterior walls, to increase the airtightness of the home, and to simplify the air sealing procedures. One major advantage of exterior insulation is that the insulation can be installed in a single plane without thermal bridging from studs or floor joists. In addition, the existing framing and sheathing is kept warm, reducing the risk of condensation and decay.

The exterior insulation attachment strategy is important to the integrity of the whole wall system. Special care must be taken to ensure the insulation and siding will remain attached to the wall and will not allow excess moisture into the system.

17 | Interior Retrofit

An interior insulation retrofit is best performed in conjunction with other interior demolition or remodelling work. A double-stud approach can be used to ensure the wall cavity is deep enough to achieve adequate wall R-value, and to avoid excessive thermal bridging. The main focus with all interior insulation retrofits is making the interior plane properly airtight and closed to vapour diffusion, as deep stud walls present a relatively high risk of condensation on the exterior sheathing.

The following design considerations are for a double-stud retrofit. The information is meant to give an overview of the wall assembly and work required.

Design Considerations: Interior Retrofit

- 1 Remove existing finishes and insulation (if any) to expose the exterior wall assembly. Inspect and repair framing and sheathing as needed.
- 2 Construct inner stud wall with framing as required, with a gap between the interior and exterior stud wall sized according to the desired R-value. Seal all edges along the floor and ceiling with polyurethane sealant.
- 3 Insulate stud space with blown-in or batt insulation.
- 4 Install polyethylene air barrier/vapour retarder and seal all joints and laps, at all penetrations, and seal to the interior framing.
- 5 Install and finish interior gypsum board as required.



When polyethylene sheet is used as the interior air barrier, sealant is installed between the polyethylene and the bottom plate and between the bottom plate and the floor sheathing to ensure airtightness.

Note: The polyethylene should run across the plane of the interior framing where interior dividing walls intersect with the exterior wall, ensuring air barrier continuity. Alternate materials may be used as long as the air barrier system is continuous.

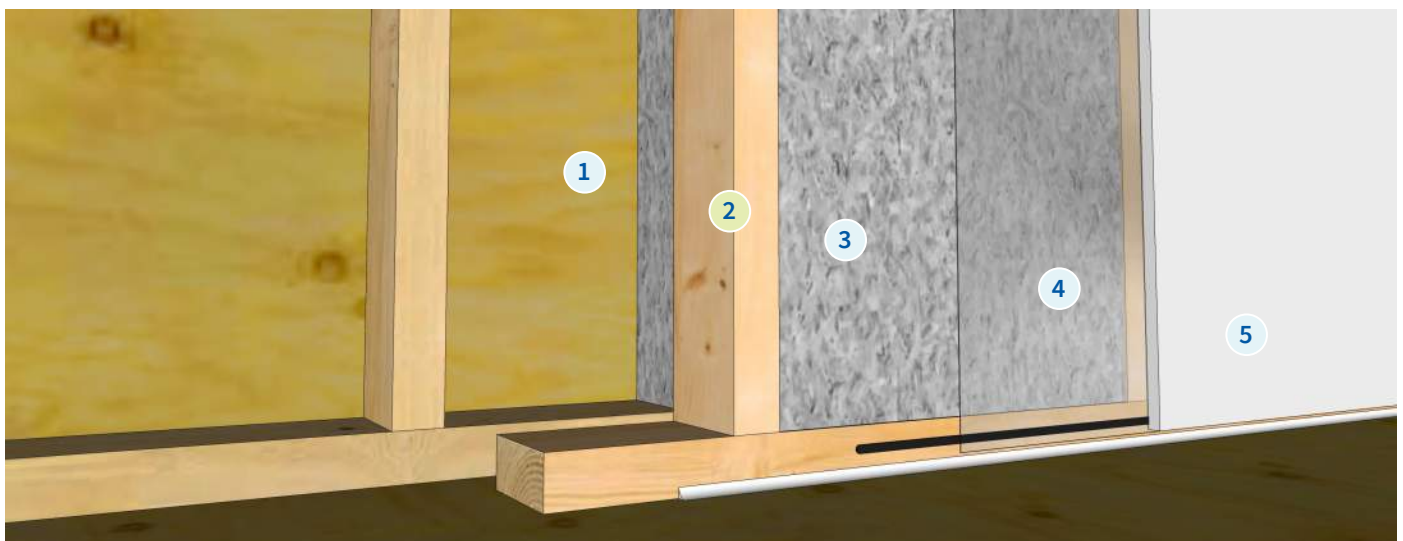

18 | Exterior Retrofit

An exterior insulation retrofit is most economical when done in conjunction with other exterior remodeling work. It is important that the existing wall is stripped down to the sheathing. In addition, the interior wall assembly should be verified to ensure the exterior work will not create a risk of condensation or trap moisture in the assembly. As a general rule, only vapour-permeable air barrier membranes and insulation should be used on the exterior of the wall. The following design considerations are for an exterior insulation retrofit. The information is meant to give an overview of the wall assembly and work required.

Windows and doors should be removed and re-installed, or replaced in conjunction with the exterior insulation work, in order to achieve adequate air- and moisture-barrier detailing.

Foundation Wall to Above-grade Wall Transition

Air barrier continuity as well as drainage is important at the interface between the bottom of the above-grade wall and the top of the foundation wall. The exterior wall air barrier should be properly tied onto the foundation wall air barrier membrane/plane of airtightness. This should be achieved while providing positive lapping to ensure proper drainage of incidental water.

Windows

It is recommended that existing windows and doors be replaced during an exterior retrofit, as they often have poor thermal resistance and may be significant sources of air leakage. Many aspects should be considered when choosing replacement products. For further information on replacement considerations and installation see [Windows and Doors](#) on page 80, and the industry guide *Best Practices for Window and Door Replacement in Wood-Frame Buildings* published by the Fenestration Association of BC and BC Housing (see [Additional Resources](#) on page 84).



Replacement doors and windows are installed before the exterior insulation. For this project the air barrier approach was sealing all the gaps of the existing plywood sheathing.

Above-grade Wall at Sloped Roof Interface

Air barrier continuity is important at the interface between the top of the above-grade wall and the attic/ceiling plane. Special attention must be paid to this transition in order to ensure the exterior wall air barrier ties into the ceiling air barrier membrane/plane of airtightness. This can be achieved with exterior self-adhered membrane, sealants, or spray foam at the top of the wall framing.

Design Considerations at Foundation Wall to Above-grade Wall Transition

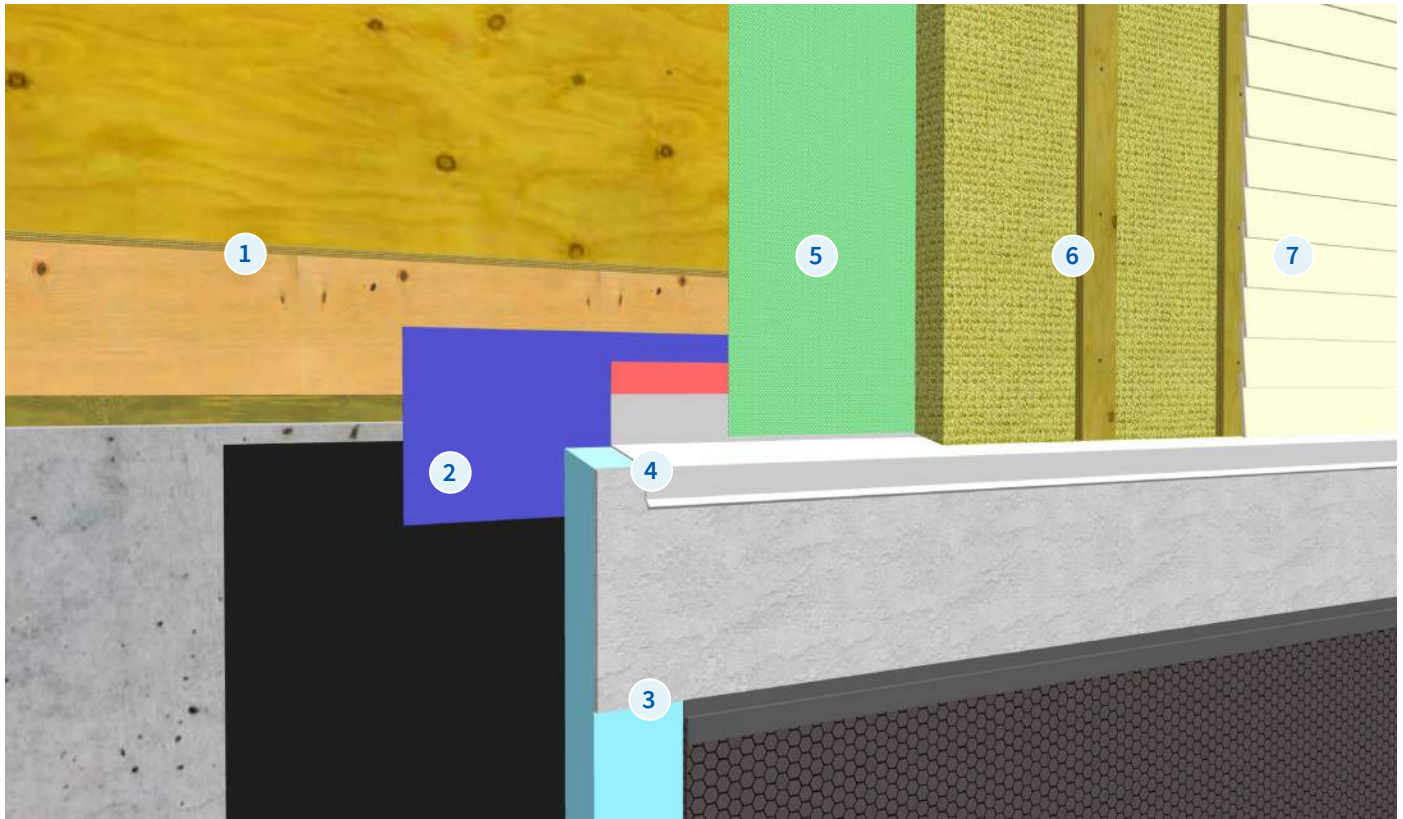

- 1 Remove the existing siding and wall membrane to expose the exterior wall assembly. Inspect and repair framing and sheathing as needed. Expose the below-grade wall assembly. Repair concrete and waterproof membrane/dampproofing as needed.
- 2 Use self-adhered membrane at the floor joist/foundation wall to create the air barrier transition.
- 3 Install below-grade wall exterior insulation with protection board over the exposed insulation above grade.
- 4 Install flashing and tape it to self-adhered membrane to maintain air barrier continuity.
- 5 Install vapour-permeable air barrier membrane (sheet, self-adhered, or liquid applied). Seal laps and penetrations, and cover the rim joists and interfaces down to the below-grade wall transition.
- 6 Place rigid mineral wool insulation over the wall membrane. Use pressure-treated wood strapping or plywood over the exterior insulation aligned with the wall stud spacing where possible. Attach with screws through the insulation into the existing wall.
- 7 Install exterior siding. Most cladding types are well supported by the strapping and screws. Heavy weight cladding such as stone veneer or brick may require extra support.

See [Additional Resources](#) on page 84 for additional considerations and details.

Design Considerations at Flanged Window

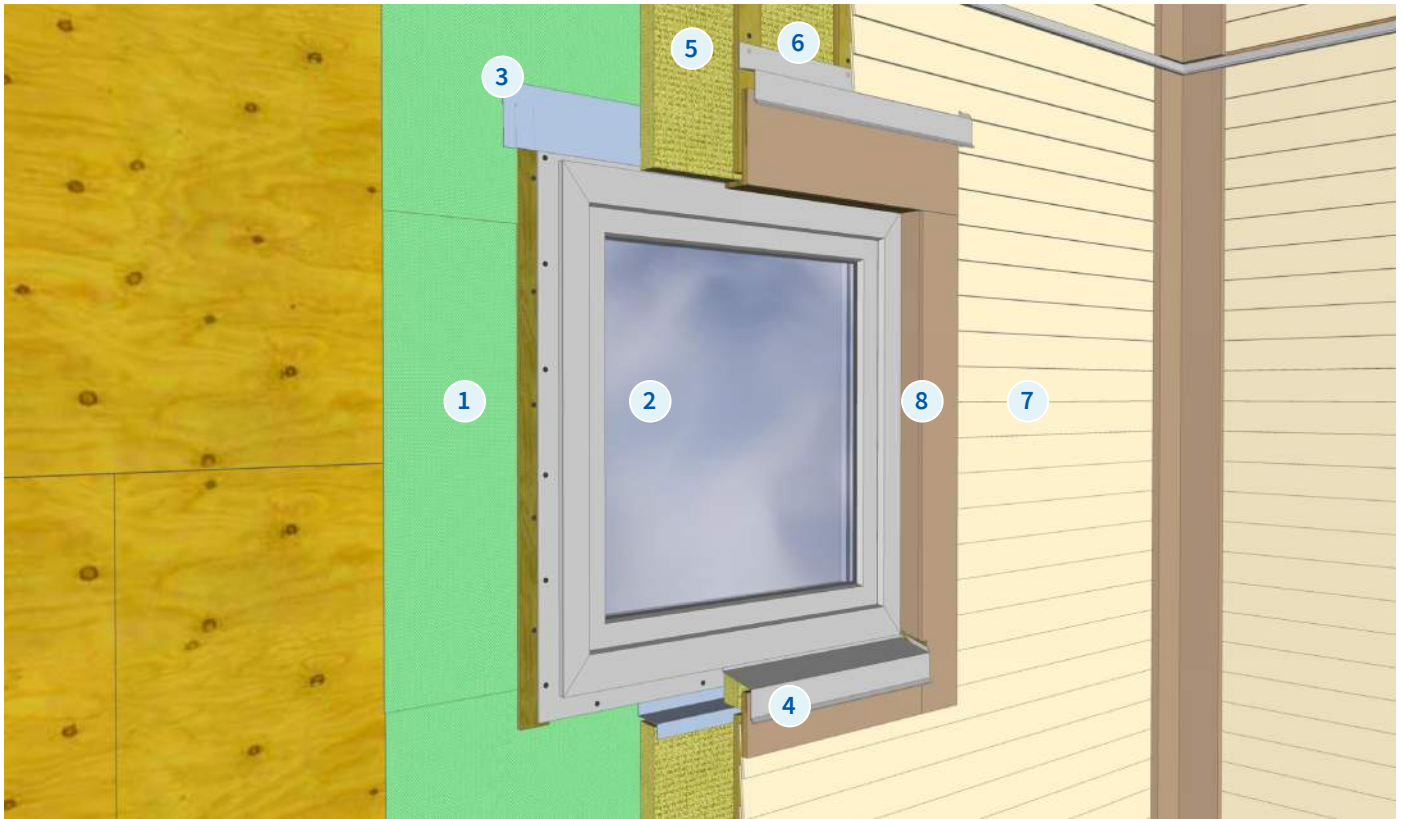

- 1 Apply a vapour-permeable air barrier membrane (sheet, self-adhered, or liquid applied) onto the window rough opening and surrounding wall area. Install extended membrane flashing at the window sill to shed water from the window rough opening out over the exterior insulation.
- 2 Install flanged window and fasten through strapping at the head and jambs, and intermittent blocking at the sill flange for drainage.
- 3 Install self-adhered membrane flashing over the window head and jamb flange.
- 4 Install metal flashing at the window sill to extend over exterior insulation and siding.
- 5 Place rigid mineral wool insulation over air barrier membrane. Use pressure-treated wood strapping or plywood aligned with stud spacing where possible. Attach with screws through the insulation into the existing wall.
- 6 Install metal flashing onto strapping above the window head to deflect moisture out over the window.
- 7 Install exterior siding. Most cladding types are well supported by the strapping and screws. Heavy weight cladding like stone veneer or brick may require additional support.
- 8 Install finish trim (or cladding returns) where needed to cover the depth of the exterior insulation on all exposed sides.

See [Additional Resources](#) on page 84 for additional window rough opening preparation sequencing information, including other building enclosure considerations and details.

Design Considerations at Above-grade Wall at Sloped Roof Interface

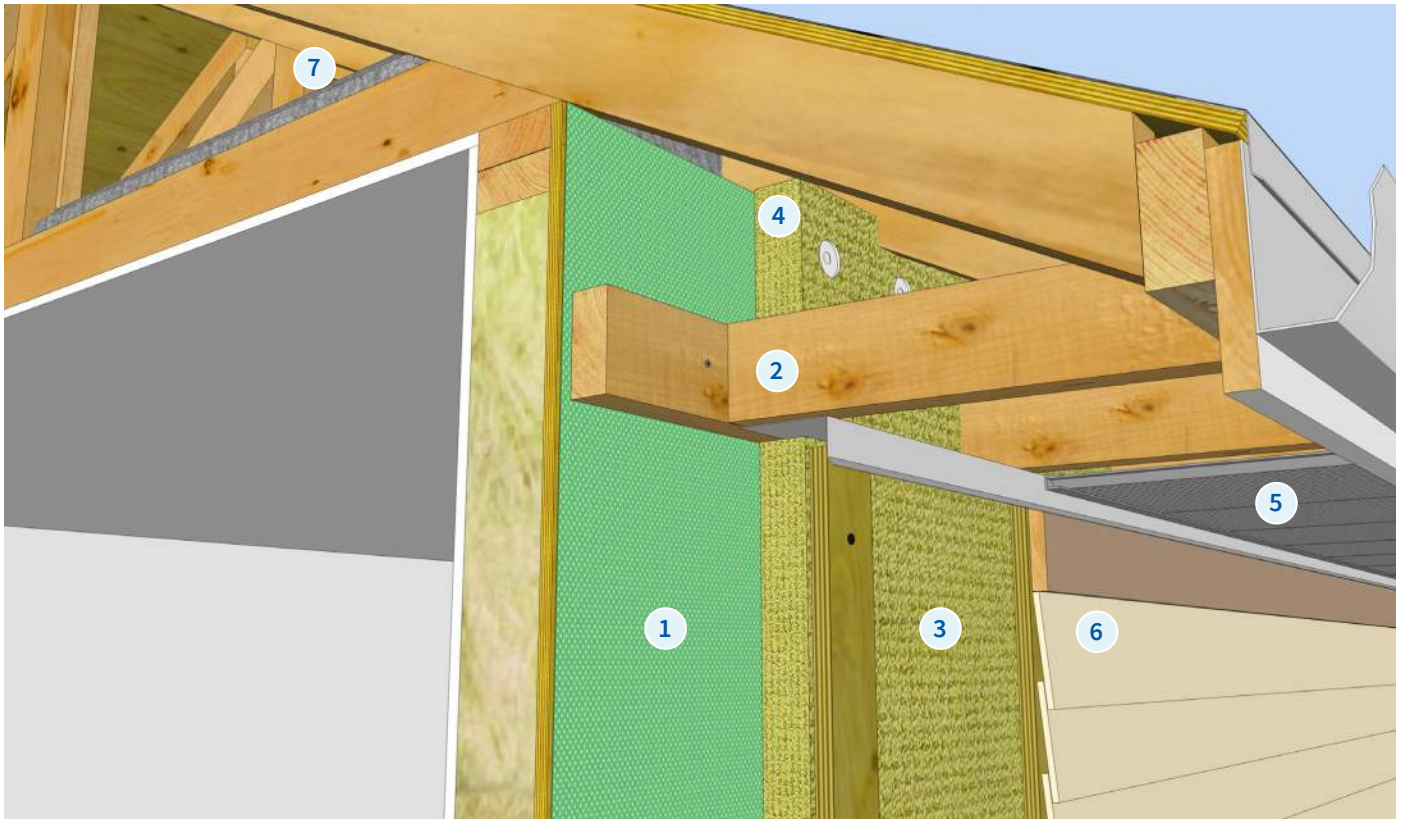

- 1 Apply a vapour-permeable air barrier membrane (sheet, self-adhered, or liquid applied) onto the exposed wall sheathing. Install self-adhered membrane (if needed) at the top of the wall to create air barrier continuity between the sheathing membrane and the wall sheathing.
- 2 Install a closure flashing above the wall insulation and strapping to separate wall drainage cavity from attic ventilation.
- 3 Place rigid mineral wool insulation over the air barrier membrane. Use pressure-treated wood strapping or plywood aligned with stud spacing where possible. Attach with screws through the insulation into the existing wall.
- 4 Place rigid mineral wool insulation at the top of the wall, cut to fit around soffit framing or behind new soffit framing. Attach with fasteners through plastic washers or strapping and screws.
- 5 Install perforated panel or ventilation ports at the soffit to allow ventilation into the attic.
- 6 Install exterior siding. Most cladding types are well supported by the strapping and screws. Heavy weight cladding such as stone veneer or brick may require extra support.
- 7 Complete exterior insulation work in conjunction with air sealing and insulation work at the attic/ceiling plane.

See [Additional Resources](#) on page 84 for additional considerations and details.

19 | Overhanging Floors

Air sealing and insulating overhanging floors is important to the overall building energy performance and thermal comfort of the home. The exposed underside of the floor can be a significant source of heat loss, due to air leakage and lack of insulation. It can also create cold floors and walls. The exposed floor is similar to a floor over an uninsulated crawlspace, and it is expected the subfloor and flooring will act as the bulk of the air barrier and vapour retarder. Air sealing is required at all joints and penetrations, and services in the overhang also must be insulated.

This air sealing and insulating procedure is for exterior overhanging floors. A similar procedure should be used for floors over car ports or other exposed floors.

Items to Avoid

- Do not rely on friction fit for the batt insulation to stay in place in the floor joist.

Items to Incorporate

- Seal at the rim joist and around all penetrations in the floor overhang.
- Use insulation supports if a flexible soffit like perforated vinyl is being used.
- Insulate and air seal duct work if exposed in the floor overhang.



Overhanging floor under a bay window.

Materials/Tools Needed

- Spray foam (spray can or two-part) and/or polyurethane sealant
- Fibreglass or mineral wool batt insulation
- Insulation retention system

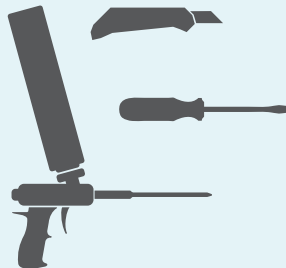

Homeowner Tips

Ensure garden sprinklers are directed away from the walls and overhang soffit to avoid excessive wetting.

Procedure: Overhanging Floors

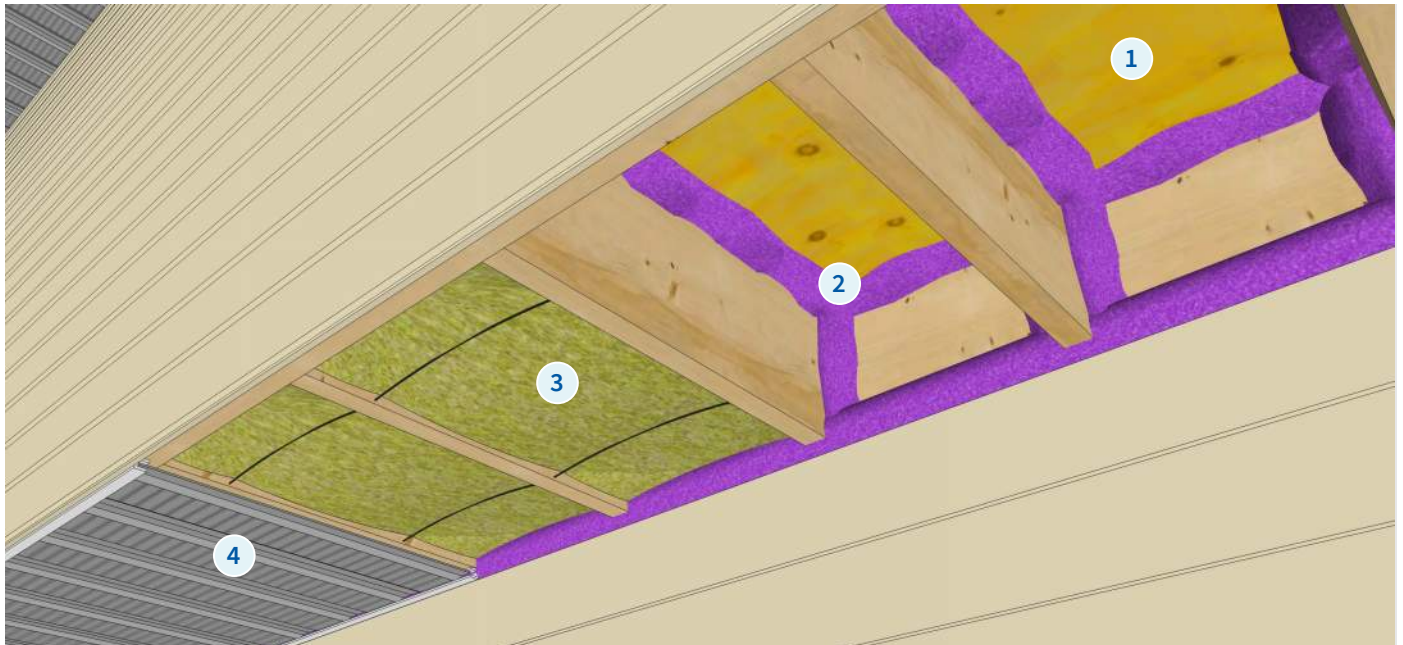

- 1 Expose the underside of the overhang, remove existing insulation (if any), and clean the framing and subfloor.
- 2 Install spray foam sealant around all penetrations and joints at the subfloor and rim joist.
- 3 Install batt insulation in each joist space and secure it in place with insulation supports.
- 4 Re-install the soffit material.

20 | Protected Porches Over Living Space

In many older homes, there is a porch over the foundation wall and basement or crawlspace that is protected by an overhanging roof. This is essentially a ceiling that must be made airtight. If major exterior work is planned, the porch should be made airtight and insulated from the exterior if space permits. Where the existing exterior finishes and membranes are to be left in place, the enclosure assemblies around the porch must be made airtight and insulated from the interior.

This air sealing and insulating procedure is meant for exposed protected porches over living space at the house perimeter that cannot be readily vented. It should not be used for conventional flat roofs or vaulted ceilings. For guidance on air sealing and insulating a ceiling from the interior, see [13 | Interior Retrofit](#) on page 50.

Items to Avoid

- Do not perform this work if there is water damage to the existing assembly.
- Do not use this approach on an unprotected horizontal surface (i.e. no overhanging roof), that should instead be designed as a roof.

Items to Incorporate

- Ensure a continuous air barrier by sealing the perimeter of the gypsum board as needed and finishing the joints.
- Ensure an effective vapour retarder is installed by using vapour-retarding paint.



Non-insulated floor between a protected porch and a living space.

Materials/Tools Needed

- Spray foam (spray can or two-part) and/or polyurethane sealant
- Fibreglass or mineral wool batt insulation
- Extruded polystyrene
- Materials needed for gypsum board finish
- Vapour-retarding interior paint

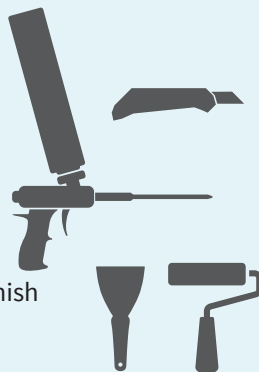

Homeowner Tips

Consider enclosing existing perimeter decks over living space to make the deck space an interior space and avoid exposed exterior floors.

Procedure: Overhanging Floors

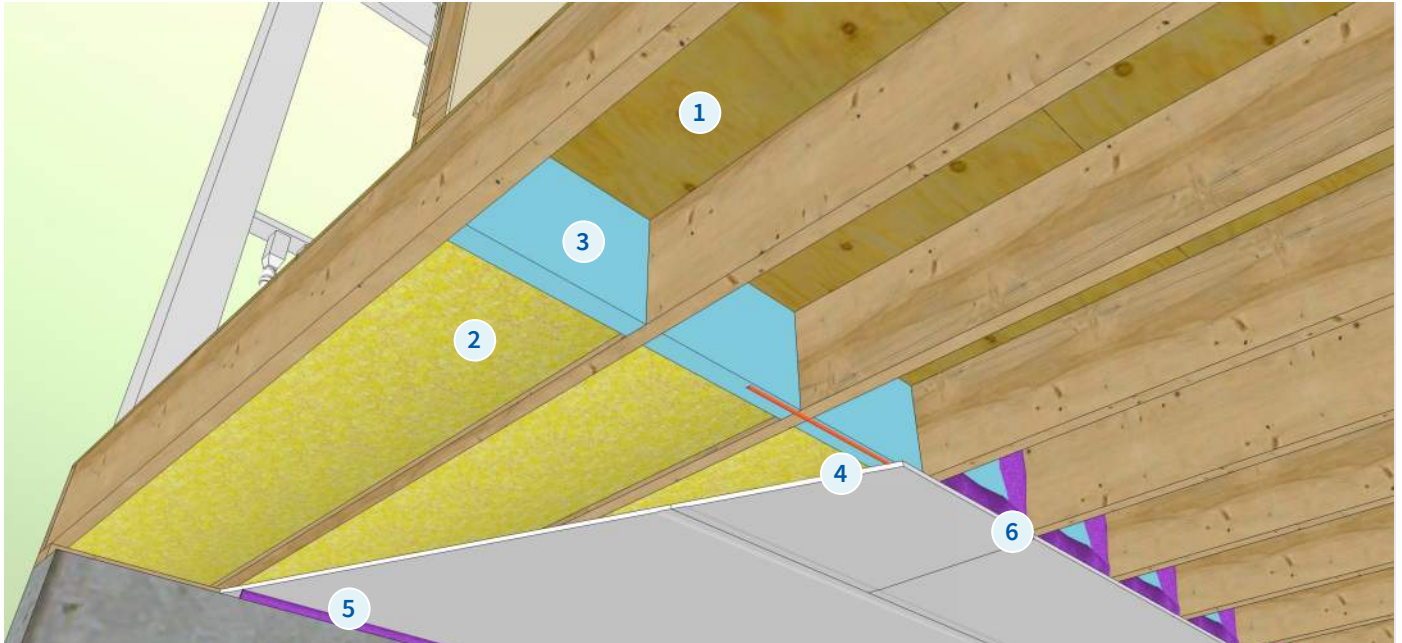

- 1 Expose the underside of the existing floor sheathing. Inspect the framing and sheathing for damage or decay and repair as needed.
- 2 Install batt insulation to the depth of the floor joists. Insulation is only needed to the extent of the exposed exterior floor.
- 3 Install rigid foam insulation at the end of the insulation where it lines up with the interior space above.
- 4 Install gypsum board to cover the floor insulation in an air-tight manner. The inner edge of the gypsum board should extend past, and be sealed to, the rigid foam board.
- 5 Seal along the outer edge of the ceiling gypsum board at the exterior wall.
- 6 Install spray foam sealant around the rigid foam, sealing it to the floor sheathing, floor joists, and the top side of the gypsum board.
- 7 Install additional gypsum boards to finish the ceiling if desired. Tape and mud all joints and paint the ceiling with a vapour-retarding paint.

Typical Air Sealing Locations at Below-grade Walls

Air sealing at the basement level is important to the airtightness of the whole house. Air sealing measures at below-grade walls are possible only from the inside, unless work is planned to expose the foundation wall from the outside.

There are typically many unsealed and exposed penetrations in an unfinished or partially finished basement. The main focus of air sealing should be at the rim joist around the perimeter of the basement.

If foundation cracks or penetrations are leaking water from the exterior, a foundation waterproofing contractor should be retained.



Partially finished basement/crawlspace with pony wall lacking an air barrier/vapour retarder.

Typical Air Sealing Locations and Procedures at Below-grade Walls:

- 1 Seal penetrations in any wood-frame walls above basement pony walls, including any discontinuities in the polyethylene sheet using acoustical sealant and sheathing tape (at polyethylene joints). Install polyethylene sheet if missing.
- 2 Seal cracks in the foundation with polyurethane sealant.
- 3 Seal floor joists at the rim joist with foam board and spray foam.
- 4 Apply polyurethane sealant between the foundation wall and basement slab to seal gaps between the concrete slab and wall.
- 5 Seal service penetrations in the basement foundation wall with spray foam or sealant.

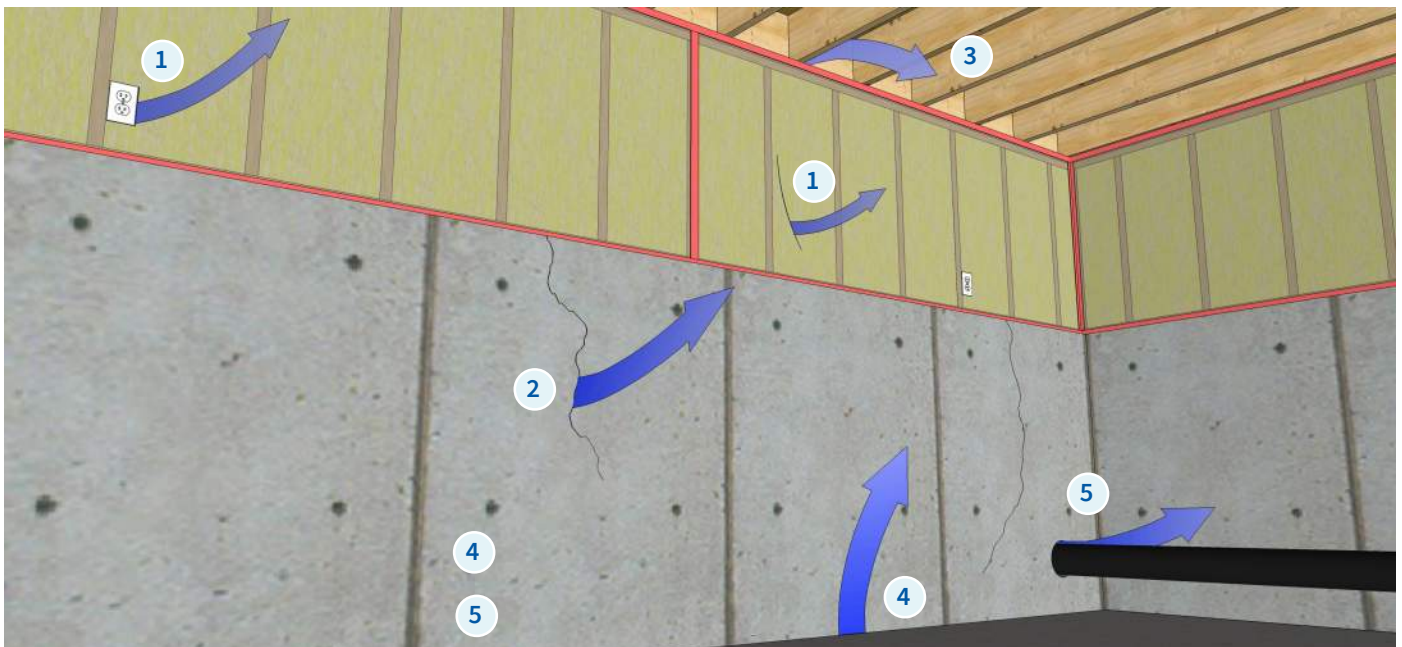

Interior Versus Exterior Insulation

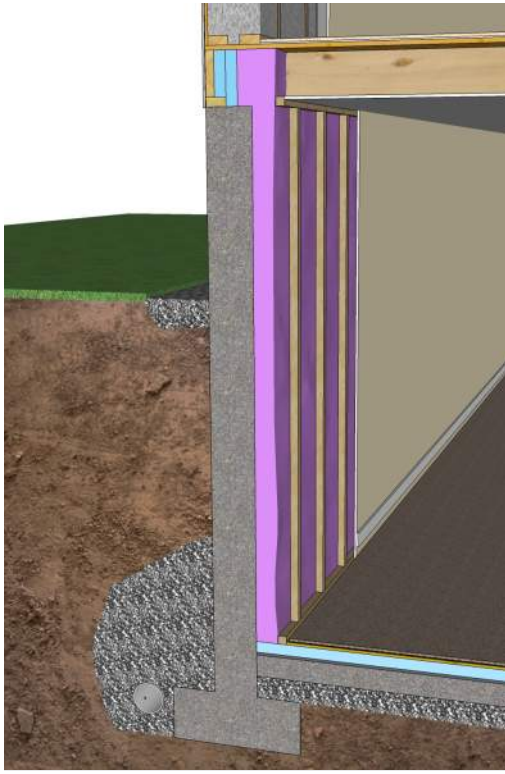

Below-grade wall after an interior insulation retrofit.

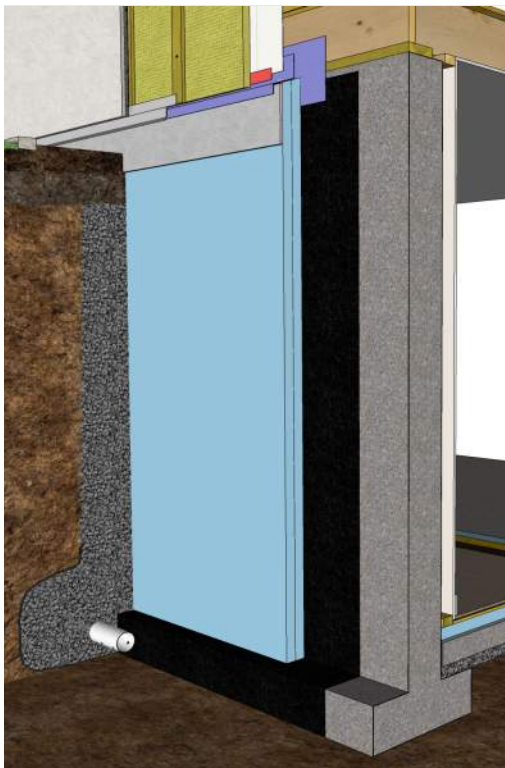

Below-grade wall after an exterior insulation retrofit.

Below-grade walls should be insulated and air sealed as part of the energy-efficiency measures for the whole house. An insulated basement can reduce energy consumption and associated costs, and create a more comfortable living space.

Insulating below-grade walls from the interior is best suited for basements where interior finishing or re-finishing is planned. It can also be more economical than exterior insulation methods, which require excavation around the foundation walls. Rigid foam insulation boards or spray foam can be installed on the interior side of the foundation wall. As with all interior insulation methods, it is important to prevent relatively warm, moist interior air from contacting the concrete foundation wall, because this can pose a significant condensation risk.

Insulating foundation walls from the exterior often provides the best performance, but can be cost prohibitive unless installed in conjunction with other exterior foundation work, such as perimeter drainage repair or dampproofing. If the wall is excavated for other work, installation of exterior insulation is straightforward.

Exterior insulation on below-grade walls is most effective when done in conjunction with exterior insulation on above-grade walls, as it greatly simplifies transition detailing and limits the potential for thermal bridging. As with other types of assemblies, exterior insulation on below-grade walls increases the temperature of the foundation wall and reduces the potential for condensation on the interior.

Basement slabs are generally airtight unless large cracks or holes are present. See [25 | Floors and Slabs on Grade](#) on page 80 for further information on air sealing procedures for the basement slab. The slab could also be insulated with rigid foam and finished. Many of the considerations for floor-slab insulation are similar to those for insulation of the below-grade walls.

The following two sections cover two conceptual below-grade wall insulation retrofits for an existing home on a concrete foundation, using either an interior or exterior insulation approach.

21 | Insulating Procedure: Interior Approach

Insulating the interior of the basement walls prior to finishing is an effective way to increase the thermal performance and airtightness of the house. The basement is prone to excessive air infiltration due to stack effect, which can create negative pressures at the basement, drawing in cold air from the ground and outside. Prior to insulating, air sealing must be done on any large openings and around service penetrations. If foundation cracks or penetrations are leaking water from the exterior, a foundation waterproofing contractor should be retained.

This insulating procedure is for below-grade foundation walls in basements where foamed plastics must be covered for fire protection.

Items to Avoid

- Do not leave rigid foam exposed in the basement. Refer to the building code for guidance on exposed foamed plastics. Typically, a layer of gypsum board is sufficient to cover the foam.
- Do not install fibreglass insulation against the concrete wall. Fibreglass is not recommended in this application.

Items to Incorporate

- Foam insulation is not permitted to be left exposed in basements. Install wood furring and gypsum board as required to protect the insulation installed on the foundation walls and rim joists. Alternatively, consider using noncombustible rigid mineral wool insulation with an airtight facer as the wall insulation.
- Ensure an airtight assembly is used in conjunction with installing insulation. Special attention should be paid to air sealing the rim joists.
- Spray polyurethane foam insulation could be used as an alternate to the rigid foam board insulation.
- Ensure there is a gap between the basement wall finish and the slab, to prevent potential moisture uptake in the drywall.



Exposed below-grade wall at floor rim joist.

Materials/Tools Needed

- Extruded polystyrene
- Spray polyurethane sealant (spray can or two-part)
- Sheathing tape and sealant
- Wood framing and gypsum board
- Insulation attachment system or glue



Homeowner Tips

Regularly inspect the perimeter of the basement floor at the foundation wall to make sure no leakage or condensation is entering the living area.

Procedure: Interior Insulating of Below-grade Wall

1



Expose the basement foundation walls and the rim joist. Remove existing insulation (if present) and clean the rim joist and floor joists.

2

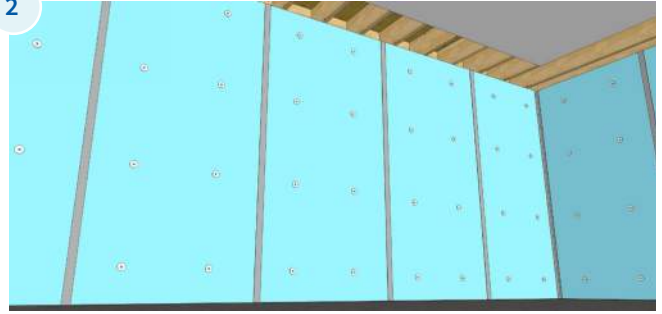

Install rigid foam insulation on the basement walls per manufacturer's instructions.

Tape the joints of the insulation with sheathing tape and seal the bottom edge of the insulation to the basement floor slab.

3

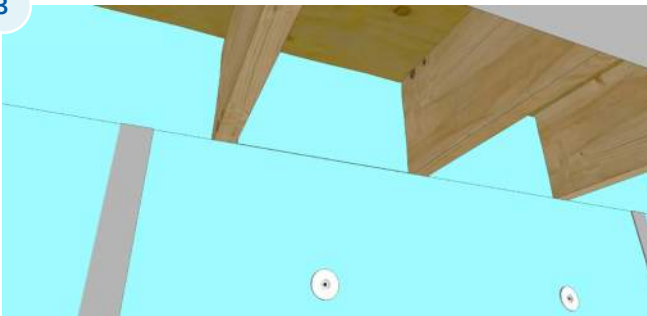

Install rigid foam insulation into each joist space. Size each piece to fit snugly in the joist space and cut around penetrations. Use multiple layers to achieve the desired insulation value.

4

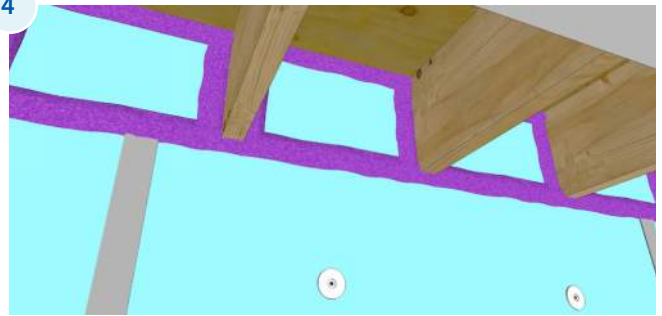

Install spray foam around the perimeter of the rim joist insulation, sealing it to the subfloor above, floor joists, and wall insulation.

Install or re-install the ceiling finish. Install wood furring and minimum 1/2" gypsum board finish on the foundation walls. Rigid foam board cannot be left exposed in living spaces. Ensure there is a gap between the gypsum and the concrete floor slab.

Note

Foamed plastics must be covered for fire protection when used in living areas such as the basement. A space is considered a basement when it is used for occupancy, exceeds 6' in height (1.8 m.), is used as a mechanical plenum for supply or return air, or contains flue pipes (except PVC pipes from high-efficiency appliances). If the space is not a basement it can be considered a crawlspace. Foamed plastics in a crawlspace are not required to be protected from fire and smoke spread. In single family homes, the sub floor above the crawlspace functions as the required protection of the living area from the adjacent concealed crawlspace and foamed plastics.

22 | Insulating Procedure: Exterior Approach

Insulation on the exterior of the foundation wall can be the easiest way to increase the thermal performance of the below-grade walls, providing exterior foundation work is already taking place. In most cases, the concrete wall will act as the air barrier. Regardless, cracks and penetrations must be sealed before insulating. In addition, the foundation dampproofing must be continuous. If exterior siding work is also taking place, the above-grade wall air barrier can be interfaced with the foundation wall air barrier, simplifying the air sealing procedure at the rim joist. If siding work is not planned, care must be taken to ensure the new materials properly tie in to the existing above-grade wall with positive laps. Air sealing from the interior at the rim joist is likely still needed in this case.

These insulating procedures are for below-grade walls that will be backfilled and exposed at the top edge.

Items to Avoid

- Do not insulate over the foundation footing or drain tile because this will block drainage of the foundation wall.

Items to Incorporate

- Ensure there is a continuous air barrier at penetrations and cracks in the foundation wall. Repair leaky holes as needed prior to installing insulation.
- Ensure the top edge of the flashing above the insulation properly interfaces with the adjacent above-grade above.



Adding exterior insulation to below-grade walls during foundation work is an effective way to increase the thermal performance of the wall.

Materials/Tools Needed

- Extruded polystyrene and parge coating
- Insulation attachment system
- Drain mat, flashing, and nails
- Wall membrane materials (if required)

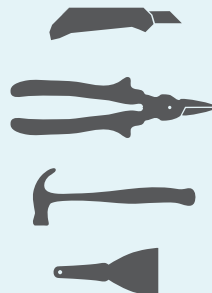

Homeowner Tips

Consider installing exterior wall insulation as part of a whole house insulation retrofit.

Procedure: Exterior Insulating of Below-grade Wall (No Siding Work)

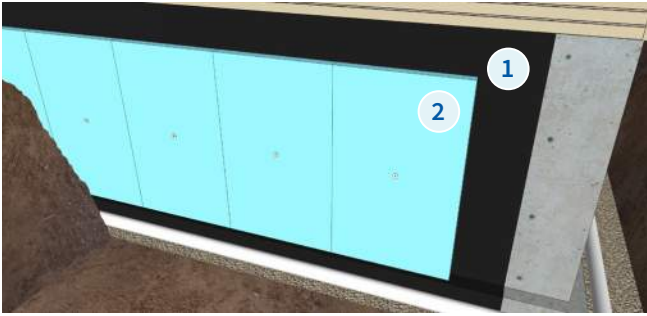

- 1 Ensure there is a continuous coating of foundation damp proofing membrane.
- 2 Install rigid foam board in the field of the foundation wall. Attach with insulation pins as required to temporarily hold the insulation to the wall.

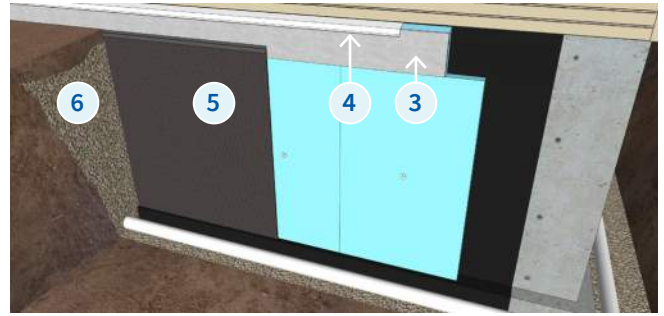

- 3 Install insulation board with a parge coating where the foundation wall will be exposed above grade.
- 4 Install flashing over the top edge of the insulation board and properly lapped behind the existing cladding and sheathing membrane.
- 5 Install drain mat over the insulation.
- 6 Backfill as required

Procedure: Exterior Insulating of Below-grade Wall (With Siding Work)

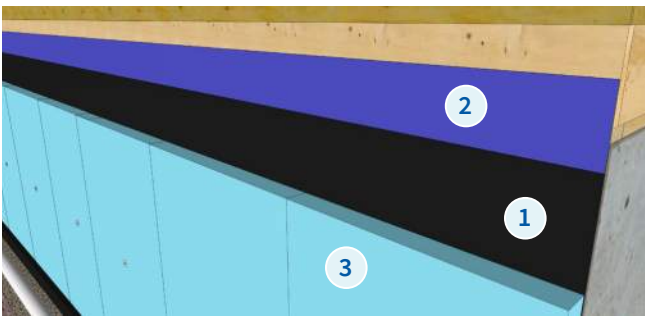

- 1 Ensure there is a continuous coating of foundation damp proofing membrane.
- 2 Install a strip of self-adhered membrane over the rim joist and sill plate, and on to the foundation wall.
- 3 Install rigid foam board in the field of the foundation wall. Attach with insulation pins as required to hold the insulation to the wall.

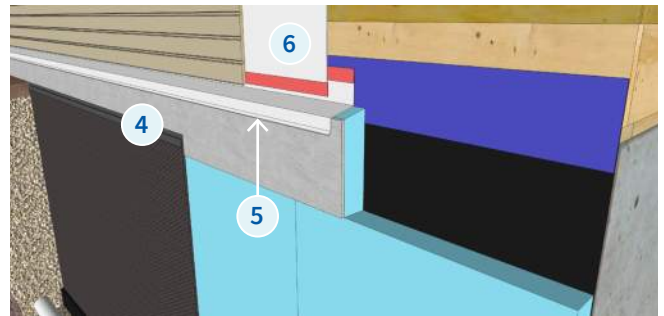

- 4 Install insulation board with a parge coating where the foundation wall will be exposed above grade. Install drain mat and back fill as required.
- 5 Install flashing over the insulation board. Tape the top edge of the flashing to the self-adhered membrane strip.
- 6 Install the airtight sheathing membrane over the above-grade wall. Tape the bottom edge to the flashing and install siding as required.

23 | Suspended Floors Over Crawlspace

Air sealing of the suspended floor over a crawlspace mainly consists of sealing all penetrations and large holes with appropriate materials like spray foam, sealant, wood, and gypsum board. See [Air Sealing Considerations for Accessible Attic Ceiling Spaces](#) on page 18 for guidance. In most cases, the subfloor and flooring acts as the main air barrier and vapour retarder, separating the conditioned space from the crawlspace. Insulating the joists can be challenging if there are services and lateral bracing in the joist space. It is important to install the insulation with a snug fit around all crawlspace obstructions.

This air sealing and insulating procedure is for floors above vented crawlspaces.



Air vent in the rim joist in an insulated vented crawlspace.

Note

This option is less durable compared with converting the crawlspace to conditioned interior space. Refer to [24 | Vented to Unvented Crawlspace Conversions](#) on page 76.

Items to Avoid

- Do not seal the exterior crawlspace vent(s). Ventilation is required in an unheated crawlspace.

Items to Incorporate

- Seal around all penetrations in the floor and insulate all water lines and ducts in the crawlspace.
- Ensure the batt insulation fits snugly into the joist space, without being compressed.

Materials/Tools Needed

- Extruded polystyrene
- Batt insulation
- Spray polyurethane sealant (spray can or two-part)
- 15 mil polyethylene sheet and sheathing tape
- Tape or sealant compatible with polyethylene and concrete
- Insulation retention system

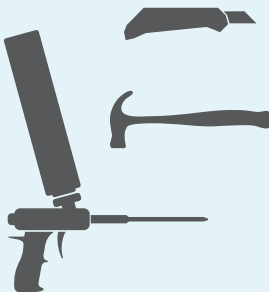

Homeowner Tips

Protect the polyethylene sheet on the crawlspace floor with carpet or rubber mats if foot traffic is expected in the crawlspace.

Procedure: Suspended Floors over Crawlspace



- 1 Install 15 mil polyethylene sheet on the crawlspace floor and mechanically fasten or tape it to the exterior walls and all other upturns at the floor and seal laps on the floor.
- 2 Install rigid foam board between floor joists at the rim joist. Size them to fit snugly between floor joists.
- 3 Install spray foam around all joints at the rim joist and seal to the wall.
- 4 Install batt insulation in each joist space and secure it in place with insulation supports.

Note

All mechanical ducts, water lines and other services running in the vented crawlspace and through the ceiling should be made air tight and insulated.

24 | Vented to Unvented Crawlspace Conversions

Air sealing and insulating the crawlspace walls can often be a simpler approach than air sealing and insulating the floors, because the services running in the floor space do not have to be insulated. In a heated crawlspace, the crawlspace walls are insulated to make the space conditioned like the rest of the home. Ventilation from the exterior is not needed and existing vents should be sealed. Also, steps must be taken to stop moisture from the ground from entering the crawlspace. The main focus for air sealing is the rim joists and is similar to the interior approach to insulating a basement.

This air sealing and insulating procedure is for the interior approach only. Similar results can be achieved from the exterior.

Other insulation types such as spray foam can be used as alternatives to rigid foam board. However, batt insulation is not recommended as there is potential for condensation on the inside face of the concrete.

Items to Avoid

- Do not proceed if the crawlspace is damp or water is present on the floor.
- Do not use exposed foam where fire protection of combustibles is needed. Cover foam with gypsum board where required or consider using noncombustible rigid mineral wool insulation with an airtight facer.

Items to Incorporate

- Seal around all penetrations in the crawlspace walls.
- Use spray foam and rigid foam board at the joists to achieve higher insulation levels and a proper air seal.
- Ensure there is adequate air circulation from within the living space down into the crawlspace, to allow the space to be conditioned as interior space. This may include mechanical ducting or simply a pass-through grill.



Uninsulated crawlspace interior walls and floor.



Crawlspace walls insulated with spray foam left exposed.

Materials/Tools Needed

- Extruded polystyrene and tape and/or closed-cell spray polyurethane foam
- 15 mil polyethylene sheet and sheathing tape or acoustic sealant
- Tape or sealant compatible with polyethylene and concrete
- Insulation attachment system



Homeowner Tips

Protect the polyethylene sheet with carpet or rubber mats if foot traffic is expected in the crawlspace.

Procedure: Vented to Unvented Crawlspace Conversions

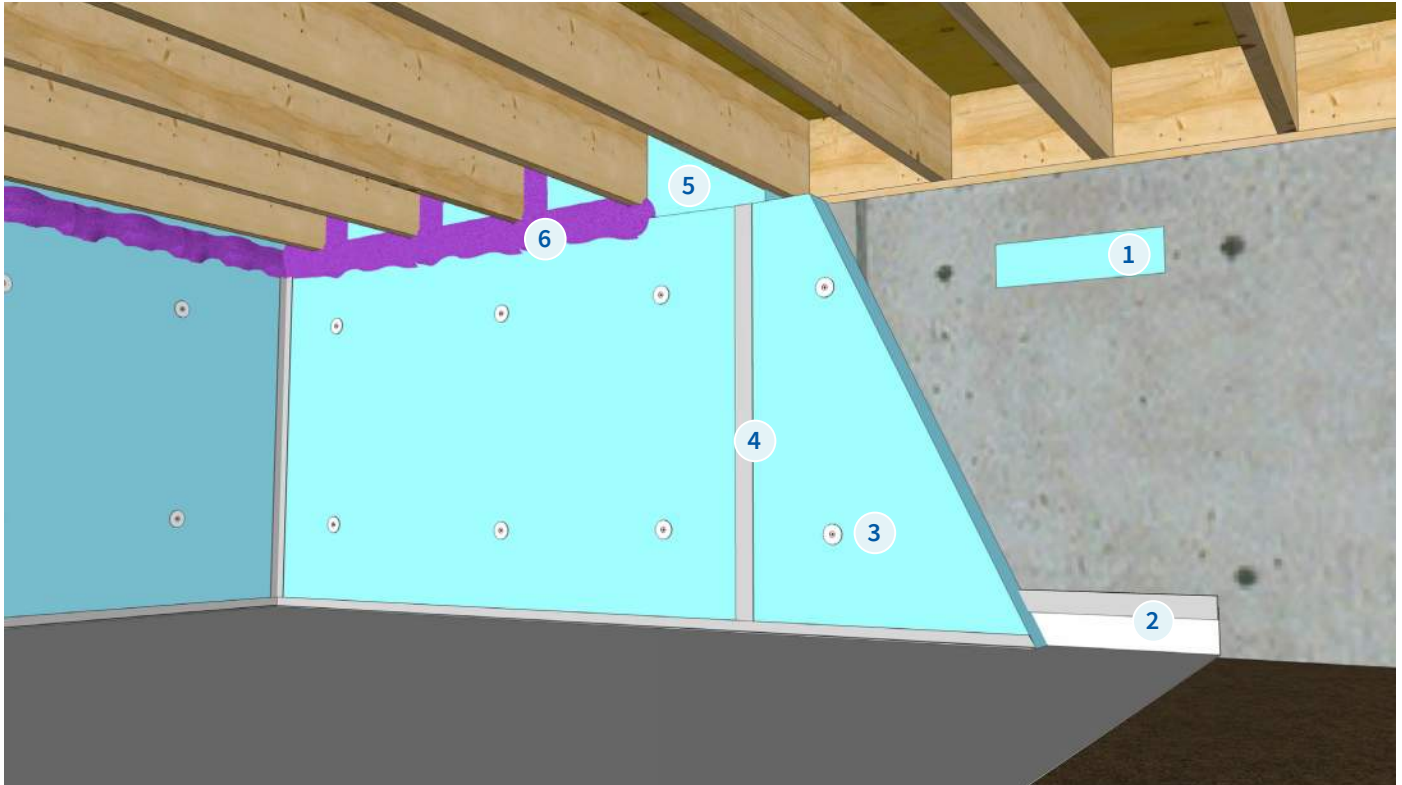

- 1 Close off and seal exterior crawlspace vents against water and air.
- 2 Install 15 mil polyethylene sheet on the crawlspace floor and seal it to the exterior walls and all other upturns at the floor and at laps on the floor with acoustical sealant and tape.
- 3 Install rigid foam board on the exterior wall and attach with mechanical fasteners.
- 4 Tape all insulation joints with compatible sheathing tape to make airtight.
- 5 Install rigid foam board between floor joists at the rim joist. Size them to fit snugly between joists.
- 6 Install spray foam around all joints at the rim joist and seal to the wall insulation.

Note

Foamed plastics must be covered for fire protection when used in living areas such as the basement. A space is considered a basement when it is used for occupancy, exceeds 6' in height (1.8 m.), is used as a mechanical plenum for supply or return air, or contains flue pipes (except PVC pipes from high-efficiency appliances). If the space is not a basement it can be considered a crawlspace. Foamed plastics in a crawlspace are not required to be protected from fire and smoke spread. In single family homes, the sub floor above the crawlspace functions as the required protection of the living area from the adjacent concealed crawlspace and foamed plastics.

25 | Floors and Slabs on Grade

When assessing whether to air seal crawlspace and basement floors, and what air sealing method to use, the floor make up and frequency of use should be considered. Many crawlspaces have dirt, bedrock or gravel floors which should be covered completely. If the crawlspace is used frequently it may compromise the air seal. Slab-on-grade floors are easier to air seal since only cracks and penetrations in the concrete need to be sealed.

The following procedure provides several options on how to air seal a slab-on-grade floor. It is recommended that a vapour retarder be used to reduce the humidity level in the space. This can be achieved with polyethylene sheets. If the space is frequently accessed, a more durable alternative is to apply an epoxy concrete sealer to the floor.

Items to Avoid

- Do not proceed if the crawlspace/ basement is damp or water is present on the floor.
- Do not use exposed foam where fire protection of combustibles is needed. Cover foam with gypsum board where required or consider using noncombustible rigid mineral wool insulation with an airtight facer.

Items to Incorporate

- It is recommended that a radon test be completed. If radon is detected, consult with a radon protection specialist to determine the best way to protect against radon exposure. This may include completely covering the existing slab with a continuous air barrier, and provide dedicated soil gas exhaust from under the slab.
- Seal around all penetrations in the floor.

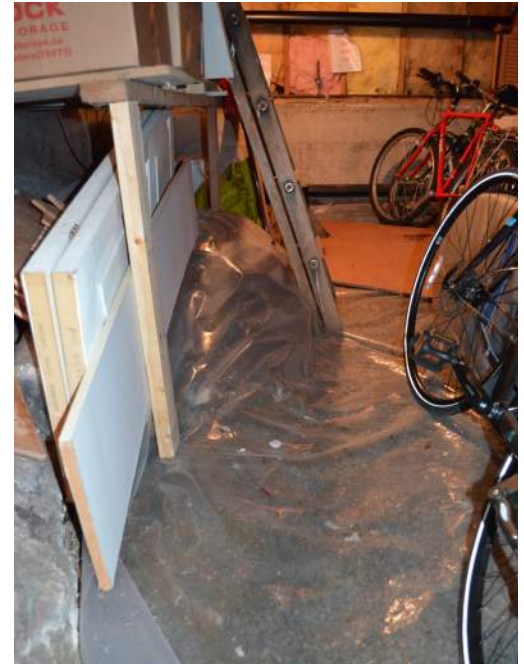

Certain floor conditions are difficult and impractical to air seal. Here a polyethylene sheet has been placed on top of the gravel and bedrock floor to reduce vapour drive into the crawlspace. The polyethylene in this frequently used basement will most likely be damaged.



Cracks in the slab and gaps between the slab and the foundation wall.

Materials/Tools Needed

- Spray foam (spray can or two-part) and/or polyurethane sealant
- 15 mil polyethylene sheet and sheathing tape
- Tape or sealant compatible with polyethylene and concrete
- Mesh and thin-set mortar

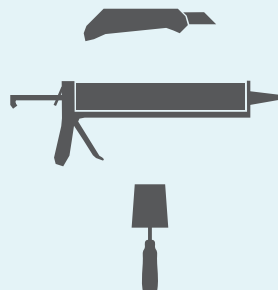

Homeowner Tips

If installed, protect the polyethylene sheet with carpet or rubber mats if foot traffic is expected.

Procedure: Floors and Slabs on Grade

1

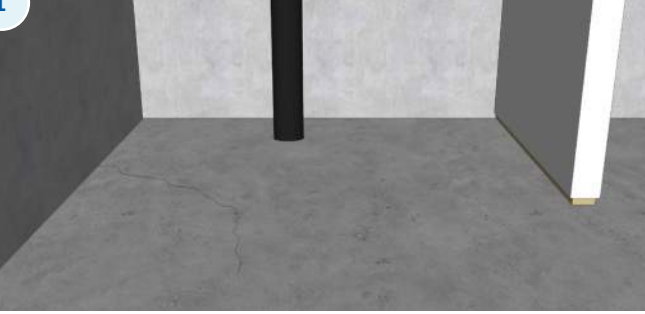

Expose the slab-on-grade floor at penetrations and interfaces. Consider removing all existing floor coverings, if present, to expose cracks in the concrete.

2

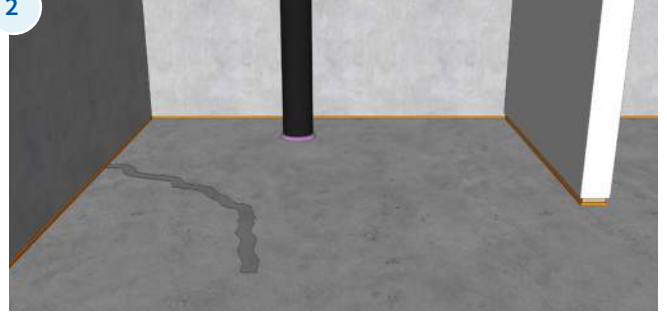

Seal along the slab edge, cracks in the floor, at interfaces, and around penetrations. This can be done with spray polyethylene sealant, polyurethane sealant, or crack fill kits. Alternatively, mesh and thin-set mortar can be applied to seal cracks in the concrete floor.

Alternative Procedure

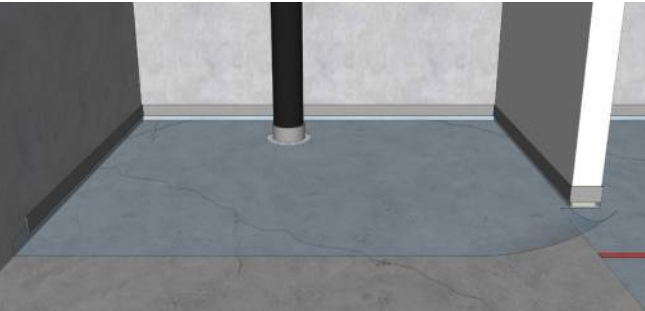

For slabs with many openings and cracks, consider installing a continuous air barrier membrane over the whole slab, such as polyethylene or a self-adhesive membrane. The seams of the polyethylene sheets should be sealed, and a compatible tape or sealant can be used to seal the polyethylene to walls and penetrations.

Windows and Doors

Windows and doors can be a significant source of air leakage, especially in older homes. Air leakage can not just occur at the joint between the window or door product and the wall, but also through the joints between the operable sashes and the fixed frame. While air leakage between the window and the wall is relatively easy to control, reducing air leakage through the joints of the product can be more challenging.

Even well maintained windows and doors eventually need to be replaced due to age, usage, and exposure to weather. When it is not possible to address uncontrolled drafts, condensation, and operational problems, consider replacing the windows and doors.

Remediation Opportunities

From the exterior, the installation joints between the windows and doors can be inspected and repaired as needed. Damaged trim and sealant can be removed and replaced.

From the interior, applying narrow beads of sealant at the joints between window and door frames and adjoining interior wall surfaces can greatly reduce air leakage at these locations. Building occupants may be aware of problem areas that need attention, and sealing all such joints is a relatively inexpensive task.

Side hinged doors are often characterized by significant air leakage, whether due to worn or faulty weather seals, or warping of the door slabs. Unlike windows and sliding doors, these products use fairly standard interchangeable components. Generic weather seals in the door frame can be easily replaced, and retrofit mouldings with flexible contact surfaces can be installed to follow the profile of a permanently warped door sash. Adjustable door bottom weather seals are also easy to replace.

Dealing with air leakage between the fixed and operable portions of windows and sliding doors is more challenging. Depending on the age of the product, replacement seals may be difficult or impossible to find. Sometimes the air leakage is due to swinging sashes that don't close properly due to sagging or worn bar hinges, or worn out roller assemblies for sliding sashes. Replacement parts can be hard to come by, and some problems cannot be affordably repaired. In these cases, replacement of the window or sliding door is usually necessary.

Replacement Considerations

Replacing windows is significantly more challenging than installing them into new homes, yet the work is often performed by contractors who lack the necessary training and experience. It is not uncommon for replacement products to be installed in ways that leave the walls more vulnerable to air leakage and moisture problems than they were before.

To address this challenge, the Fenestration Association of BC and BC Housing jointly published the industry guide *Best Practices for Window and Door Replacement in Wood-Frame Buildings* (the Guide) in 2013 (see [Additional Resources](#) on page 84).

As it is often not practical to install replacement windows in the same way as the original products, the Guide provides a variety of robust installation methods from full removal of existing windows to installations that safely leave part of the existing frame within the wall.



It may be desirable to replace windows and doors in cases where poor installations may have led to deterioration of the wall framing. The image above shows extensive decay visible at a window rough-opening interface detail upon removal of cladding. Damage extends well beyond window replacement work area.

Homeowner Tips

As a companion to the Guide, BC Housing also developed a *Consumer Guide to Window and Door Replacement* that addresses the key issues homeowners should consider when replacing windows and doors. This guide is available online at www.bchousing.org.

Key Installation Objectives

The Guide identifies five key installation objectives that every installation must meet. The Guide does not advocate a single installation method. Instead, it provides example installation details that satisfy these installation objectives for a variety of wall types, existing window frame types, replacement frame types, and exposure conditions.

1 Determine Rain Exposure Conditions

The Guide shows how to identify which windows and doors are most vulnerable to exposure from driving rain and therefore require more robust water penetration control, based on the extent of overhang protection, the location of the building, and the surrounding terrain.

2 Develop an Effective Water Penetration Control Strategy

The basic objective of every replacement installation is to make the installation at least as good as the existing situation, and if possible, to improve on deficiencies in the existing situation. The Guide shows how the sound principles of a first and second plane of protection, required by the building code, can be achieved in every installation.

3 Ensure Air Barrier Continuity

Airtightness is not only important for energy efficiency and comfort — it is essential for effective water penetration control. Ensuring air barrier continuity between the existing wall assembly and the new window or door is a key aspect of all installation details.

4 Minimize Condensation Risk

Most non-metal replacement windows have significantly greater condensation resistance than the windows they are replacing. Detailing that minimizes thermal bridging and air leakage, and locating windows closer to the interior wall surface are among the measures that mitigate condensation risk.

5 Provide Structural Anchoring and Support

The appropriate anchoring and shimming of windows can be product-specific and are therefore dependent on the manufacturer's recommendations. The Guide addresses the general principles, but does not provide details for all conditions.



A window located on a facade with low rain exposure, protected by a large overhang.



Windows being installed on a high wind- and rain-exposed facade with no overhang protection.

Example Replacement Procedure: Recessed Window with Stucco Cladding

This procedure is based on ‘Installation Detail Series 3’ from the Guide. It is for a window with moderate to high rain exposure.

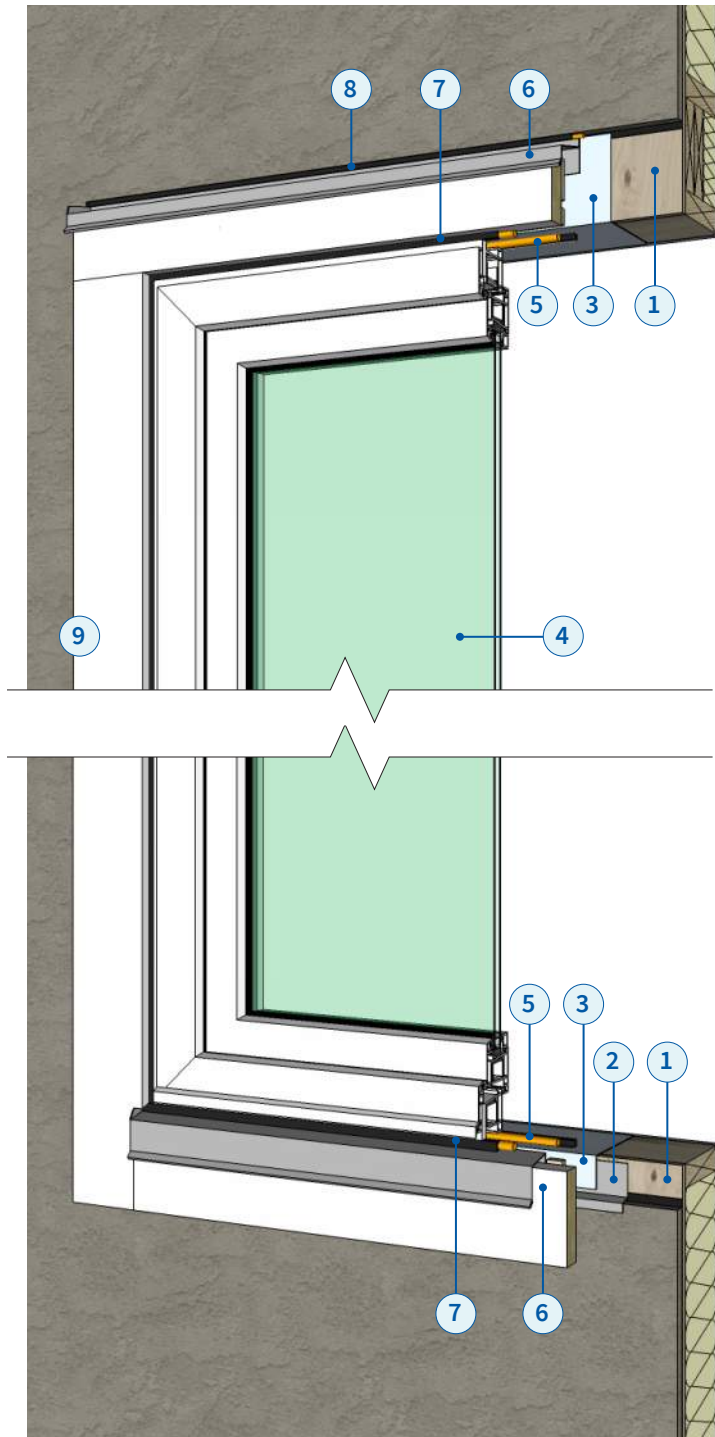

- 1 Cut back the exterior cladding and remove the existing window. Remove interior trim and prepare the rough opening as needed.
- 2 Install a strip of metal flashing on the exterior sheathing below the sill. It should be shaped to divert water onto the stucco cladding.
- 3 Install foil-faced self-adhered membrane on all four sides of the opening covering the rough opening framing, exterior sheathing and sheathing membrane, if present. The membrane placed on the sill should extend over the metal flashing. Install all membranes in a “shingle lapped” fashion, and ensure all four corners are air- and water-tight by using prefabricated corner pieces or membrane gussets. Place sealant beads where the self-adhered membrane meets the stucco cladding on either side of the window.
- 4 Place the replacement window on shims, and fasten in place as required. Fasteners should be located so as not to penetrate the sill membrane at the exterior edge.
- 5 Install backer rod and a continuous bead of sealant between the interior edges of the window and the self-adhered membrane. This provides air and water tightness.
- 6 Intermittent shims should be used to fur out the window trim to allow for incidental water to drain onto the stucco cladding at the window sill. Metal drip edge flashings should be installed to protect the horizontal edges of the trim.
- 7 Seal the exterior edges of the window to the sill flashing and trim, with intermittent weep holes at the head to allow drainage.
- 8 Seal the head trim flashing to the stucco cladding.
- 9 Place backer rod and sealant between the vertical window trim and the stucco cladding.

Example Replacement Procedure: Single Hinged Door – Stucco Clad Wall

This procedure is based on ‘Installation Detail Series 18’ from the Guide. It is for a door with moderate to high rain exposure.

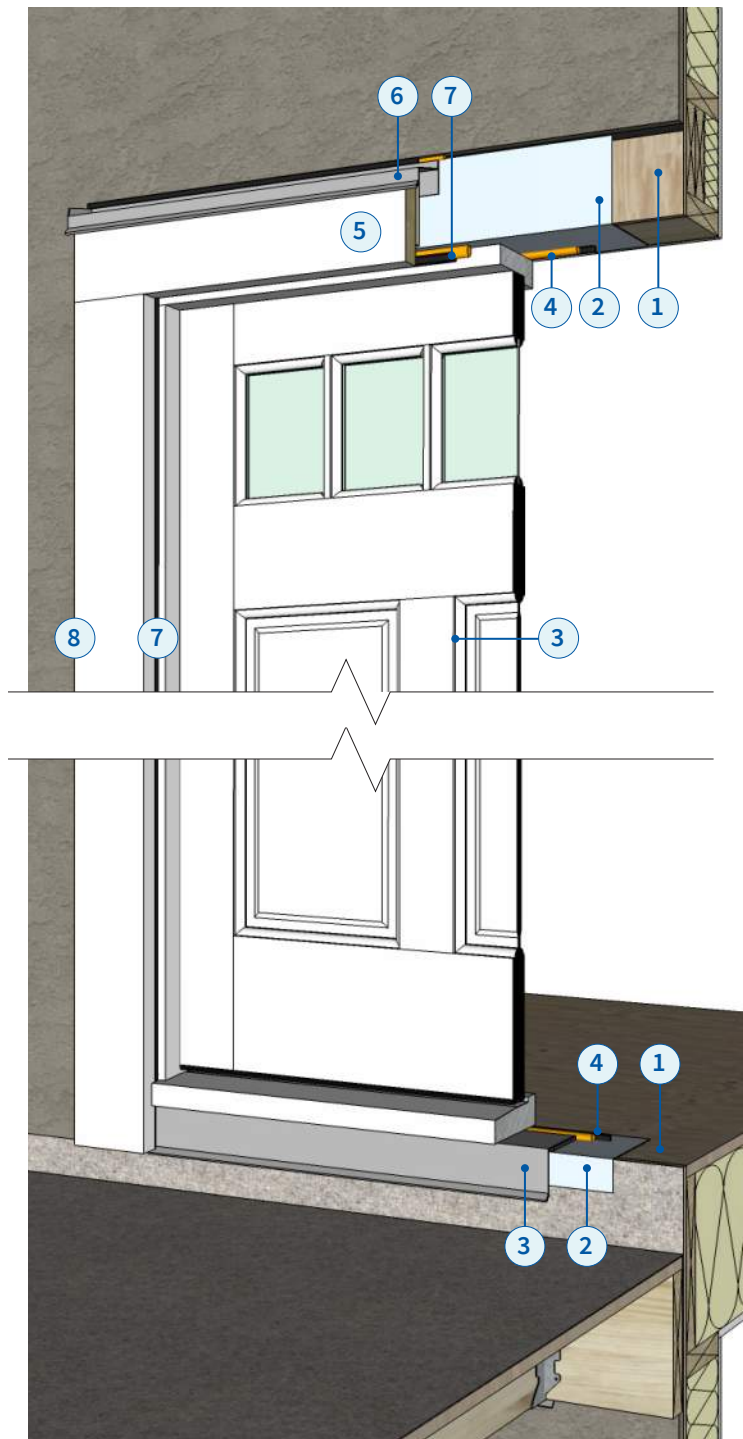

- 1 Remove existing interior trim, exterior trim and door. Prepare the rough opening as needed.
- 2 Install foil-faced self-adhered membrane on all four sides of the opening covering the rough opening framing, exterior sheathing and sheathing membrane, if present. The membrane placed on the sill should extend over existing waterproof deck membrane or cladding. Install all membranes in a “shingle lapped” fashion, and ensure all four corners are air- and water-tight by using prefabricated corner pieces or membrane gussets. Place sealant beads where the self-adhered membrane meets the stucco cladding on either side of the door.
- 3 Install the door. A metal drip edge flashing should be placed between the door sill and the shims to allow for incidental water to drain onto the deck membrane/cladding.
- 4 Install backer rod and a continuous bead of sealant between the interior edges of the door and the self-adhered membrane. This provides air and water tightness.
- 5 Fur out the exterior trim with intermittent shims to allow incidental water to drain out.
- 6 A metal drip edge flashing should be installed to protect the edge of the head trim and sealed to the stucco cladding.
- 7 Seal the exterior face of the door box frame to the inside of the trim, with intermittent weep holes at the head to allow drainage.
- 8 Place backer rod and sealant between the vertical window trim and the stucco cladding.

Additional Resources

Weatherization and Builders' Construction Guides

Best Practices for Window and Door Replacement in Wood-Frame Buildings, 2013. The Fenestration Association of BC and BC Housing.
www.bchousing.org

Canadian Home Builders' Association Builder's Manual, 2013. Canadian Homes Builders' Association.
www.chba.ca

Consumer Guide to Window and Door Replacement, 2013. The Fenestration Association of BC and BC Housing.
www.bchousing.org

Energy Out West, Weatherization Field Manual, Best Practices for the Weatherization Assistance Program, 2005. Department of Energy—Seattle Regional Office, and Energy Out West.
www.energyoutwest.org

Guide to Attic Air Sealing, 2010. Joseph Lstiburek, Building Science Corporation.
www.buildingscience.com

Illustrated Guide Energy Efficiency Requirements for Houses in British Columbia, 2014. BC Housing.
www.bchousing.org

Illustrated Guide R22+ Effective Walls in Wood-Frame Construction in British Columbia, 2015. BC Housing.
www.bchousing.org

Insulate and Weatherize. 2002. Taunton Press - Build Like a Pro™ Series, author: Bruce Harley.

Keeping the Heat In, 2012. Natural Resources Canada.
oee.nrcan.gc.ca

Mass Save Deep Energy Retrofit Builder Guide, 2013. Building Science Corporation.
www.buildingscience.com

Material Specifications, Certification and Standards

Fire-rated Sealants

Required Certification - UL Certification—UL1479

Relevant Test Methods: ASTM 814

Insulation Products

Relevant Test Methods: CAN/ULC-S701, CAN/ULC-S702, CAN/ULC-S703, CAN/ULC-S704, CAN/ULC-S705, ASTM C177, ASTM C518, ASTM C976, CFR Title 16 - Part 460, ICC-ES AC12, ICC-ES AC377, ASTM E84

Sealants for Air Sealing

Relevant Test Methods: Foam sealants: ASTM C1642, Acrylic silicone and urethane caulking: ASTM C920

Required Certification: Water based duct sealant: UL-181A-M, UL 181B-M

Tapes (for Ducts)

Required Certification: UL-181

Tapes (for Air Sealing)

Relevant Test Methods: ASTM D3330, ASTM D882

Weatherstripping

Relevant Test Methods: ASTM C509

Health and Safety

Managing Environmental Risks During a Renovation Project Builder Insight Bulletin, 2014. BC Housing.
www.bchousing.org

Combustion and Gas Safety

CSA F300 - Residential depressurization, 2013. CSA Group.

Canadian General Standards Board Guide to Attic Air Sealing, 2010. Joseph Lstiburek, Building Science Corporation.
www.buildingscience.com

Keeping the Heat In, 2012. Natural Resources Canada.
oee.nrcan.gc.ca

Lead Paint

Safe Work Practices for Handling Lead. WorkSafeBC.
www.worksafebc.com

Asbestos Hazards

Asbestos Hazards When Renovating Older Homes. WorkSafeBC.
www.worksafebc.com

Safe Work Practices for Handling Asbestos. WorkSafeBC.
www.worksafebc.com

Health Canada - It's Your Health Website.
www.hc-sc.gc.ca

It's Your Health—Vermiculite Insulation Containing Amphibole Asbestos. Health Canada.
www.hc-sc.gc.ca

Mould and Moisture

A Brief Guide to Mould, Moisture, and Your Home. United States Environmental Protection Agency.
www.epa.gov

Guidelines on Assessment and Remediation of Fungi in

Indoor Environments, 2008. New York City Department of Health and Mental Hygiene.
www.nyc.gov

WorkSafeBC OHS Guidelines Part 4 Indoor Air Quality.
www.worksafebc.com

Radon

Radon in Homes and Other Dwellings. HealthLink BC.
www.healthlinkbc.ca

Spray Foam Insulation

Spray Polyurethane Foam (SPF) Home—Design for the Environment, an EPA Partnership Program. United States Environmental Protection Agency.
www.epa.gov

Home Ventilation

Heat Recovery Ventilation Guide for Houses, 2015. BC Housing.
www.bchousing.org

Quality First Ventilation Guidelines, 2008. TECA, Surrey, BC.
www.teca.ca

Canadian Home Builders' Association Builder's Manual—Chapter 18 Ventilation Systems, 2013. Canadian Homes Builders' Association. Ottawa, Ontario.
www.chba.ca

References

In addition to the previously noted specifications, standards and suggested further information and guides, the following references were consulted in the development of this guide:

Air Sealing Homes for Energy Conservation, 1984. Canada Energy, Mines and Resources Canada. Building Energy Technology Transfer Program. Prepared by Marbek Resource Consultants.

Building Enclosure Design Guide—Wood-frame Multi-Unit Residential Buildings, 2011. BC Housing. Available for purchase at: www.bchousing.org

Energy Conservation Assistance Program (ECAP) Program Specifications, 2013. BC Hydro and Fortis BC. www.fortisbc.com

Guide for Designing Energy-Efficiency Building Enclosures for Wood-Frame Multi-Unit Residential Buildings in Marine to Cold Climate Zones in North America, 2013. FPInnovations. www.fpinnovations.ca

Insulation: A Guide for Contractors to Share with Homeowners. May 2012. US Department of Energy—Building Technologies Program. Volume 17, Building America Best Practices Series. Prepared by Pacific Northwest National Laboratory & Oak Ridge National Laboratory. www.pnnl.gov

Sealing Caulking and Weatherstripping. Manitoba Hydro. www.hydro.mb.ca

Moisture Control for Dense-Packed Roof Assemblies in Cold Climates: Final Measure Guideline. 2012. Building Science Press. Research Report 1308 - Authors Chris Schumacher and Robert Lepage. US Department of Energy & Renewable Energy Building Technologies Program. www.buildingscience.com

Near Net Zero Energy Retrofits for Houses, 2011. Canada Mortgage and Housing Corporation. Prepared by RDH Building Engineering Ltd. www.cmhc-schl.gc.ca

Retrofit Techniques and Technologies: Air Sealing—A Guide for Contractors to Share with Homeowners, 2010. Pacific Northwest National Laboratory and Oak Ridge National Laboratory.

<https://www.energy.gov>

Maine Weatherization Standards. January 2005, www.nascsp.org

Weatherization Assistance program Standard Training Curricula, 2010. US Department of Energy. www.nascsp.org

Standard Work Specifications for Single Family Home Energy Upgrades. March 2013. US Department of Energy. <https://www.energy.gov>

Building Technologies Program. US Department of Energy. <https://www.energy.gov>

Vermont's Weatherization Program Technical Policies & Procedures Manual, 2010. Vermont Department for Children & Families, Office for Economic Opportunity. www.vermont.gov

Contractor Checklist: Home Air Sealing and Insulation Procedures

Home Address		City			Contractor
Location	Inspection Guideline	Inspected and Acceptable	Correction Needed	Not Observed/ Not Applicable	Notes
Accessible Attics	Recessed Pot/Can Light				
	Attic Hatch				
	Bathroom Fan and Duct				
	Kitchen Range, Dryer, or Other Exhaust Duct				
	Fireplace or Other Combustion Appliance Vent				
	Wall Top Plate and Penetrations				
	Large Openings, Shafts, or Drop Ceilings				
	Attic Knee Walls				
	Ceiling Perimeter and Gable End Walls				
	Masonry Chimney				
	Insulation Assessment				
	Topping Up Existing Insulation				
	Flash-and-Fill Insulation				
Vaulted/Flat Ceilings	Air Sealing (Interior)				
	Interior versus Exterior Insulation Assessment				
	Interior Retrofit				
	Exterior Retrofit				
Above-Grade Walls	Air Sealing (Interior)				
	Air Sealing Washroom Exterior Walls				
	Exhaust Vents Through Walls and Soffits				
	Stud Bay Blown-in Insulation Retrofit				
	Interior versus Exterior Insulation Assessment				
	Interior Retrofit				
	Exterior Retrofit				
Exposed Floor	Overhanging Floors				
	Protected Porches Over Living Space				
Below-Grade Walls	Air Sealing (Interior)				
	Interior versus Exterior Insulation Assessment				
	Interior Retrofit				
	Exterior Retrofit				
Crawlspace	Suspended Floors over Crawlspaces				
	Vented to Unvented Crawlspace Conversions				
	Floors and Slabs-on-Grade				
	Windows and Doors				
Windows and Doors	Window and Door Assessment				
	Remediation Opportunities				
	Replacement Considerations				

Contractor Checklist: Health and Safety

As shown in Section 1 of this guide, there are various health and safety considerations for weatherization work. This page provides a checklist as a reference for contractors. The checklist does not provide comprehensive coverage of all health and safety considerations for performing this type of work as it is expected that the contractor will be adequately trained and aware of the relevant safety risks.

Potential Health and Safety Considerations:

- Ventilation while Performing Work**
Many commonly-used construction materials release potentially harmful chemicals, and adequate ventilation should be provided during work to maintain the health and safety of the workers.
- Confined Spaces and Fall Safety**
Safety precautions should be taken when working in confined spaces and areas with potential of elevated risk of injury. Practise safe ladder use and inspect areas of work to assess if a respirator is needed. Fall protection or other safety measures should be implemented to ensure safe working conditions.
- Ventilation of the Home**
Adequate ventilation of the home should be maintained after weatherization work, to ensure a healthy and comfortable indoor environment.
- Occupant Safety**
Protect the occupants from harm by blocking or sealing off access to areas of potential danger, storing tools and materials safely and out of reach of children, and ensure clear exit paths in case of an emergency.
- Radon Gas**
Radon gas is a colourless, odourless gas that, when present in significant concentrations, can create long-term health risks for occupants. When performing work in areas where radon is a potential concern, testing should be performed.
- Combustion Safety**
Weatherization work can affect the combustion safety of a home. Appropriate measures should be taken to ensure that adequate make-up air is provided for combustion appliances to avoid spillage of combustion gases into the home.
- Weatherization Materials**
Common weatherization materials such as spray foams, sealants, and adhesives can contain various harmful substances that may negatively impact the health of both workers and home occupants. Material selection and placement, and ventilation should be considered to mitigate these potential negative effects.
- Structural Elements and Connections**
These elements should not be compromised during weatherization work.
- Mould, Fungal Growth, and Moisture Damage**
Moisture damage and associated mould and fungal growth are a significant health and building durability concern that should be addressed prior to or as part of weatherization work. It is important to address the root cause of these issues, not just their symptoms.
- Asbestos and Lead**
Older building materials commonly included potentially harmful constituents such as asbestos and lead. When these materials are present and may be disturbed, appropriate abatement strategies should be implemented.
- Electrical Safety and Wiring**
Care must be taken to avoid electrical hazards while performing work. Also, in some older homes knob and tube type wiring may still be active and should be decommissioned prior to weatherization work.
- Gas Safety**
Qualified contractors should be retained when weatherization work requires the temporary movement or permanent relocation of gas lines or equipment.

Glossary of Terms and Materials

ACH₅₀	The number of times the air in a space changes in an hour (air changes per hour) when the space is pressurized or depressurized to 50 Pascals.
above-grade	The portion of a building that is above the perimeter ground surface level.
acoustical sealant	A common sealant designed for interior use where it will not be exposed to exterior conditions that may negatively affect its performance.
air barrier	The materials and components that together control the airflow through an <i>assembly</i> and limit the potential for heat loss and condensation.
air leakage	The uncontrolled flow of air through the building enclosure (i.e. infiltration or exfiltration) as the result of pressure differences and lack of <i>building enclosure airtightness</i> .
airtightness	A measure of the air permeance of the assemblies that make up the building enclosure at a certain pressure difference. Airtightness can be visualized in terms of an equivalent-sized hole in the building enclosure. Typically, airtightness is measured at a standard test pressure of 50 or 75 Pascals to overcome the effects of wind and stack effect, and to obtain a repeatable measurement.
assembly	The arrangement of more than one material or component for the purpose of performing specific overall functions.
ASTM	American Society for Testing and Materials
AT rated	A designation for electrical appliances that identifies them as airtight.
backer rod	A flexible foam material used behind sealant to increase elasticity, reduce consumption, force the caulking into contact with the sides of the joint creating a better bond, and determine the thickness of the caulking.
batt insulation	Typically relatively low-density fibrous insulation and designed for installation between studs.
BCBC	British Columbia Building Code
below-grade	The portion of a building that is below the perimeter ground surface level.
bottom plate	The lower horizontal framing member of a wood-framed wall that the bottom of the wall studs rest upon. See also <i>top plate</i> and <i>sill plate</i> .
building enclosure	Referred to in building codes as one type of environmental separator, it comprises the parts of the building that separate inside conditioned space from unconditioned or outside space. Also referred to as a building envelope.

cellulose insulation	Insulation made from processed wood fibres, commonly used as blown-in insulation in attics or between studs.
combustible construction	Construction that does not meet the requirements for noncombustible construction.
condensation	The deposition of moisture on a surface caused by moisture-laden air coming into contact with a surface that is at or below its <i>dew point</i> .
detail	A location in a <i>building enclosure assembly</i> where the typical assembly construction is interrupted by a penetration of the assembly or by interfaces with an adjacent assembly.
dew point	The temperature at which air is saturated with water vapour (100% <i>relative humidity</i> , or RH). An adjacent surface at a temperature lower than the dew point will lead to the formation of condensation on the surface.
drain mat	A sheet material typically consisting of dimpled plastic or plastic weave that facilitates the drainage of water between adjacent materials.
drying	A water management principle that utilizes features and materials to speed diffusion and evaporation of water from materials that get wet in an assembly.
EEM	Energy Efficiency Measure
extruded polystyrene insulation (XPS)	A rigid foam plastic insulation product that can be used in various applications including those where airtightness is required (when joints appropriately sealed).
fire-resistant silicone sealant	A silicone sealant designed specifically for use in high temperature applications. These sealants are commonly used as part of fire and smoke control strategies.
flange	A flat rim that projects past the sill, head, and/or jambs of a window unit, which is used for installing it in an opening. It also affords a weather seal or flashing around the perimeter of the window frame.
foil tape	Tape with aluminum facer that can be used for air sealing. The aluminum facer can also provide a suitable substrate for application of <i>sealants</i> .
fur out	The process of installing thin strips of material to level or raise surfaces of another material to prevent dampness, to make space for insulation, or to level and resurface ceilings or walls.
gypsum drywall (gypsum wall board)	Gypsum boards typically faced with paper for interior applications (other facers available for exterior applications), which can be used as part of an <i>air barrier</i> system and is also widely used to provide interior finishing.

HDD (Heating Degree Days)	Heating Degree Days is a measure that is intended to indicate the relative demand for heating of a building. It is derived from the exterior temperature and the amount of time for which the temperatures occur.
insulation baffle	Insulation baffles are typically pre-formed foam plastic products and are used at soffits to maintain ventilation space between the roof sheathing and attic insulation so that the insulation does not restrict ventilation of the attic space.
penetration	An intentional opening through an assembly for duct, electrical wires, pipes, fasteners, etc., to pass through.
polyethylene sheet	Plastic sheet commonly used as a vapour barrier, and in some applications may also be used as an air barrier when appropriately sealed.
polyurethane sealant	Urethane-based sealant that can be suitable for both air- and water-sealing applications.
relative humidity (RH)	The ratio of the amount of water vapour in a volume of air to the maximum amount of water vapour that volume of air can hold at a given temperature.
sealant	An elastomeric material that is used to form an airtight (or waterproof) bond at a joint or opening.
sheathing	A material that is used to provide structural stiffness to the wall framing and structural backing to the cladding and sheathing membrane. Oriented strand board (OSB) or plywood is typically used.
sheathing tape	Tape typically used for air sealing of the joints between sheet and board products.
shim	A thin strip of material used to align parts, make them fit, or reduce wear.
shingle lapped	A lap joint in which the sections joined are tapered so that the bottom of each section fits over the top of the section below it.
sill plate	The lower horizontal framing member that the lower floor framing rests upon. See also <i>top plate</i> and <i>bottom plate</i> .
soffit	The exposed underside of an architectural structure such as a balcony, overhanging eaves, or overhanging building section.

spray polyurethane sealant/foam (SPF)	A urethane-based spray-applied foam plastic product used for air sealing and insulation, and in some cases also used as a water resistant barrier. This product comes in two primary types: open-cell and closed-cell, which are also commonly referred to as half-pound and two-pound foams (corresponding with their densities per cubic foot), or one-part and two-part foams. Open-cell foams are typically most applicable for the air sealing of relatively small openings, and relative to closed-cell foams, open cell foams expand more when applied, and are more flexible and more vapour-permeable once they are cured. Closed-cell foams are most applicable for larger applications such as insulating between floor joists and other large penetrations. Closed-cell foams are typically vapour impermeable.
stud	A vertical framing member used in walls and partitions.
TECA	Thermal Environmental Comfort Association
top plate	The upper horizontal framing member of a wood-framed wall that the that the above floor or roof framing rests upon. See also <i>bottom plate</i> and <i>sill plate</i> .
VOC	Volatile Organic Compound
vapour retarder	A material with low vapour-permeability that is located within an assembly to control the flow of water vapour. Also sometimes referred to as the vapour barrier.
vapour-retarding paint	Typically interior paint that is relatively vapour impermeable (approximately <1 perm).
ventilation	The process of supplying air to, or removing air from, a space for the purpose of controlling air-contaminate levels, humidity, or temperature in the space.



Research Centre
1701 – 4555 Kingsway
Burnaby, BC V5H 4V8
Phone: 604 439 4135
Toll-free: 1 866 465 6873
Email: technicalresearch@bchousing.org
www.bchousing.org